

Manufacturer • Distributor

FLAGPOLES AND FLAGPOLE COMPONENTS

JANUARY 2024 EDITION



**CONCORD
AMERICAN
FLAGPOLE**

TM

Online Dealer Tools

Flagpole Designer 2.0

Create millions of individual Flagpole Specification Drawings to match the requirements of any project. **Just a click away!**

"Perfect for Architects, Designers, and Specifiers of Flagpoles."

Continental Series
ESR - External Single Stationary Rope Halyard Ground Set Installation

ESR30C61 - SAT

Specifications

A. Mounting Height:	30'
B. Set Depth:	3'-0"
C. Total Length:	33'-0"
D. Butt Diameter:	6"
E. Wall Thickness:	.156"
F. Top Diameter:	3.5"
Flagpole Sections:	1
Shaft Weight:	135 lbs.
Hardware Weight:	10 lbs.
Ground Speed Weight:	36 lbs.
Ground Speed:	6" x 10'
* Max Flag Size:	6' x 10'
* Max Wind Speed w/ Nylon Flag:	105 mph
* Max Wind Speed No Flag:	174 mph

* Wind Speed Specifications from ANSI/SAAMI FP 1001-07

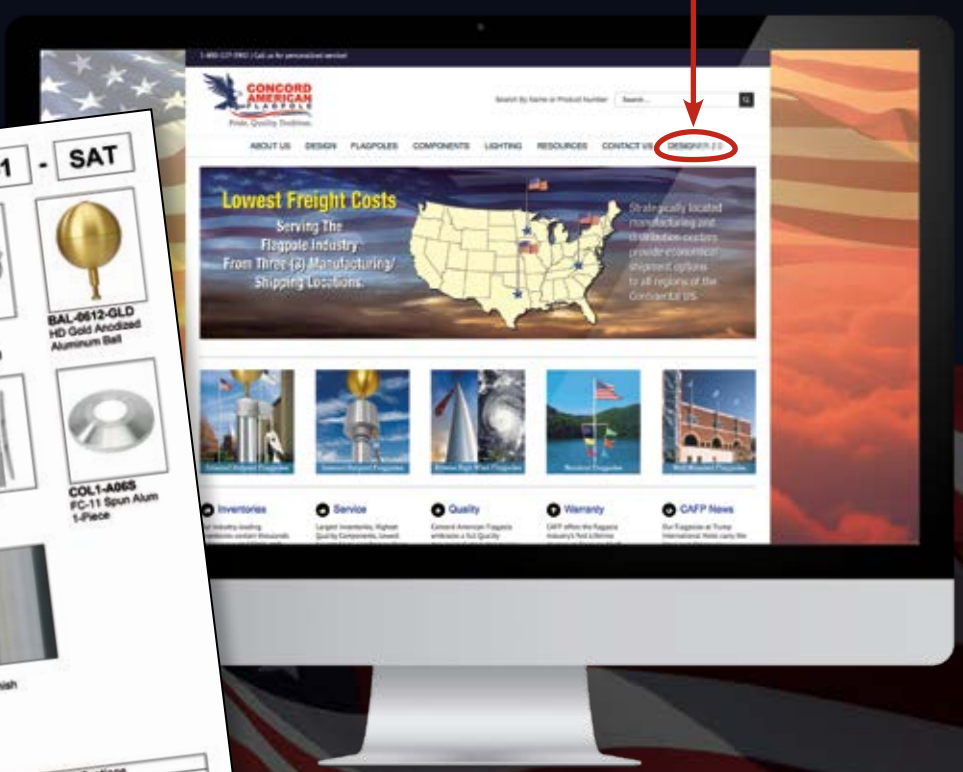

See page 89 for more Dealer Resources & Advantages



Instant Freight Quotes... Online
Concord American Flagpole's Online Freight Quotes give you instant access to the industry's Lowest Freight Costs. Visit our video tutorial at <https://www.concordamericanflagpole.com/resources/online-freight-quotes/> to learn just how easy...and fast...flagpole freight quotes can be.

Custom Specification Drawings + Instant Freight Quotes = Unparalleled Flagpole Dealer Support!

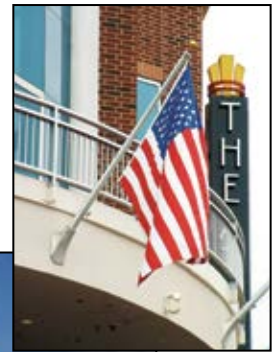
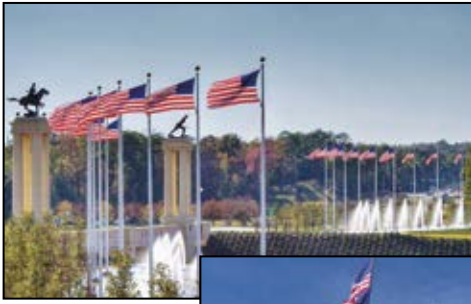

Contents

DESCRIPTION	PAGE	DESCRIPTION	PAGE
History	4	Internal Vertical Wall Mount - VIC Cam Cleat	50
Flagpole Specialist.....	5	Internal Vertical Wall Mount - VIW Winch	51
Flagpole Inventory	6-7	Flagpole Kits / Telescoping Flagpoles.....	52-55
Design - Halyard Options	8-9	Flags.....	56-57
Design - Shaft Descriptions	10	Flagpole Balls / Finials	58-60
Design - Flagpole Options	11	Eagles.....	61
Design - Custom and Specials	12	Trucks - External.....	62-64
Design - Miscellaneous	13	Ball Trucks - External.....	65
Design - Flagpole Foundations & Height.....	14	Trucks - Internal	66-67
Flagpole Windspeeds.....	15	Ball Trucks - Internal	68
Design - Finish Options	16	Miscellaneous Trucks	69
Design - Part Numbers.....	17	Halyard - External Rope.....	70-71
Estate - ESS External Single Stationary.....	18-19	Flag Arrangements	72
Continental - ESR External Single Revolving	20-21	Halyard - Internal Wire	73
Extreme - XESR External Single Revolving	22-23	Flagsnaps	74
Monarch - ICC Internal Cam Cleat	24-25	Counterweights	75
Sentry - ISC Internal Cam Cleat - Reinforced	26-27	Retainer Ring Assemblies	75
Sentry II - IRC Internal Cam Cleat - Reinforced.....	28-29	Cleats.....	76
Titan - IWW Internal With Winch.....	30-31	Halyard Security.....	77
Sovereignty - ISW Internal Winch - Reinforced	32-33	Cam Cleats, Winches and Locks	78
Independence - IRW Internal Winch - Reinforced...	34-35	Ground Sleeves.....	79
Extreme - XIWW Internal With Winch	36-37	Collars	80-81
Extreme - XIRW Internal With Winch - Reinforced ..	38-39	Internal Halyard Accessories	82
APEX - IRW Internal Winch - Reinforced.....	40-41	Miscellaneous Accessories	83
Nautical - NSM Single Mast	42-43	Flagpole Lighting.....	84-88
Nautical - NDM Double Mast.....	44-45	Dealer Resources & Advantages	89
Outrigger - OSS Outrigger Single Stationary	46-47	Flagpole Windspeed Chart.....	90-92
Vertical Wall Mount - VSS/VTS/VTR	48-49	Terms and Conditions	93-95
		Lifetime Warranty, Restocking & Storage	96-97

Concord American Flagpole has a proud history that brings over 70 years of experience to the aluminum flagpole industry. As an industry-leading manufacturer and distributor of Flagpole and Flagpole Components, we are extremely proud to offer the best flagpole value, the highest level of professional customer service and continued innovation to industry professionals worldwide.

Whether your project requires a single flagpole in a residential or business setting, flagpoles in front of memorials, parks, or corporate and government buildings or elaborate multiple flagpole designs, Concord American Flagpole has the technical competence, quality and commitment to service to ensure your success.

Asked for by name by contractors and architects, Concord American Flagpole's reputation for excellence makes us one of the most recognized...AND SPECIFIED... names in the Flagpole industry.

Engineering

Concord American Flagpole Engineering has a proud history of dedicated involvement in the research that shaped the aluminum flagpole industry. Decades of testing in our in-house R&D labs, active participation in numerous national industry organizations, and adoption of modern solid modeling techniques assure quality product designs that are guaranteed to meet or exceed current National Association of Architectural Metal Manufacturers (NAAMM) specifications. Our passion for excellence in innovation and product quality has created many products and concepts that are industry-accepted standards, with our advanced technical skill and in-depth aluminum metallurgical knowledge providing the solid foundation for the industry's leading Lifetime Flagpole Shaft Warranty (See Page 96).

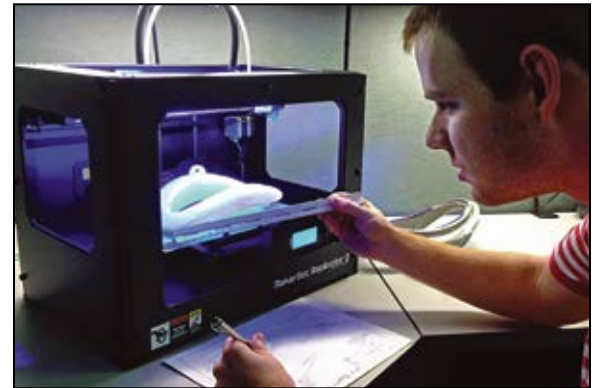

Manufacturing

Our manufacturing expertise is derived by combining the most advanced, state-of-the-art aluminum manufacturing technologies with dedicated and knowledgeable employees. Our campuses comprise over 375,000 sq. ft. of manufacturing, distribution, and administrative offices. We are dedicated to the principles of Lean Manufacturing, joining a continuous improvement process with experienced scheduling, purchasing, production, quality control, shipping and customer service specialists.



Quality Products

Concord American Flagpole embraces a full Quality Assurance System that begins with exacting raw material specifications. Aluminum shafts are constructed of 6063-T6 temper aluminum alloy with a tensile strength not less than 30,000 psi and a yield point of 25,000 psi. All shafts conform to ASTM B221. In addition, all component parts follow a strict standard inspection process, ensuring a level of quality available only with Concord American Flagpole.



**Expert Engineering Design,
World-Class Manufacturing
Capabilities and an emphasis
on Quality Control define
Concord American Flagpole.**

Flagpole Inventory

Largest Inventories

Concord American Flagpole's industry-leading inventories contain thousands of Flagpoles IN STOCK AND READY FOR IMMEDIATE SHIPMENT.

Inventories include our most popular 15' to 100' Internal and External Halyard systems in a variety of Satin, Anodized and Powder Coat finishes.

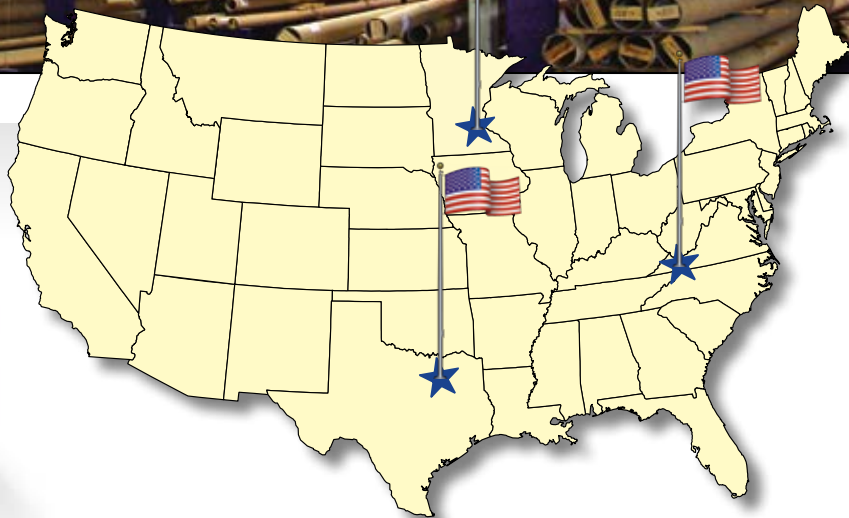
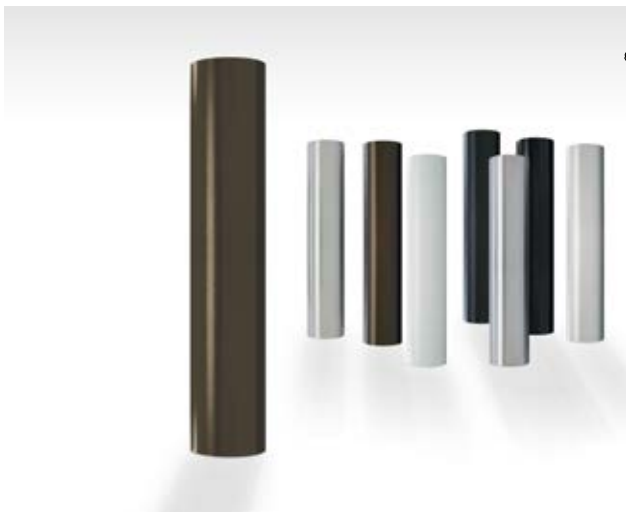

Lowest Freight Costs
Three strategically located manufacturing and distribution centers provide economical shipment options to all regions of the continental US. Options include LTL, Fed-Ex, UPS, USPS and dedicated carriers, providing the **LOWEST COST** shipping option for every project.



Component Inventory

Expansive Inventories of Quality Flagpole Components... Patented Balls, Ornaments, Trucks, Halyards, Flagsnaps, Flags, Patented Counterweights, Retainer Ring Assemblies, Cleats, Winches, Collars, Ground Sleeves and Accessories...are available for immediate shipment.



Raw Material Inventory

Our unique role as a Manufacturing Distributor allows our extensive raw material inventories to be immediately pulled into the manufacturing process.



Integrated Supply Chain

Under the ownership and leadership of Dyson-Kissner-Moran (DKM), Concord American Flagpole is the industry's only integrated flagpole manufacturer.

This integration provides...

- Supply Chain Ownership
- The Highest Quality Aluminum Shafts
- Unparalleled Engineering and R & D
- Scale and Leverage in Both Manufacturing and Shipping



Tri-City Extrusion

A leading aluminum extruder located only 20 miles from our Virginia campus.



An industry leader in aluminum products for the Light Pole Industry.



Flagpole Design - Halyard Options

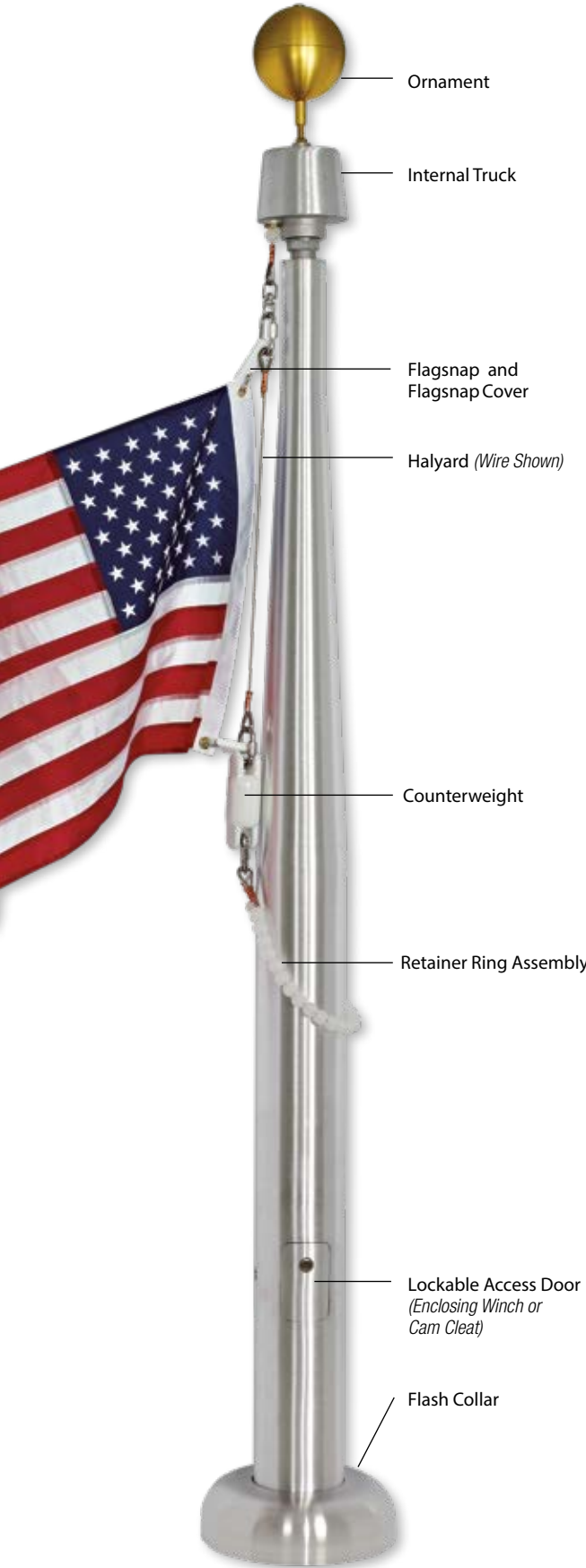

A major consideration in flagpole design is the placement of the Halyard used to raise and lower the flag. Options include Internal Halyard Systems which enclose the Halyard behind the security of a lockable access door and External Halyard Systems which place the Rope Halyard on the outside of the flagpole.

Internal Halyard Systems

Winch vs. Cam Cleat

Concord American Flagpole offers Internal Halyard designs that are specially designed for the rigorous demands of outdoor flagpole systems. Winch Systems incorporate Wire Halyard with a gearless Winch and Winch Handle. Cam Cleat Systems utilize Rope Halyard in a heavy-duty cam action cleat.

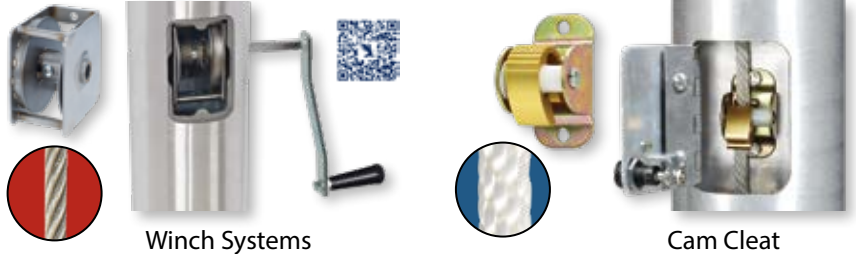

Wire Halyard

Rope Halyard

Cam Cleat

Internal Revolving Trucks vs. Internal Stationary Trucks

Internal Trucks sit at the top of the flagpole, providing an enclosed pulley system for the Wire or Rope Halyard. Options include Stationary Trucks, which are fixed and will not rotate, and Revolving Trucks, which rotate the flag with the wind.

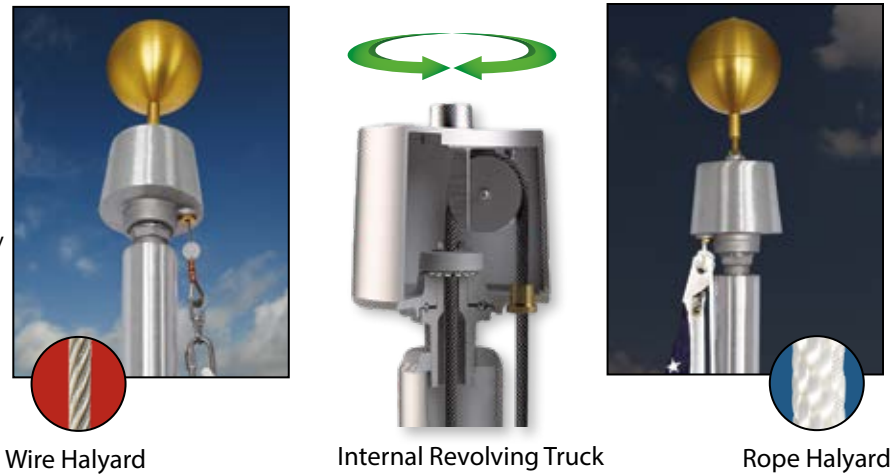

Wire Halyard

Internal Revolving Truck

Rope Halyard

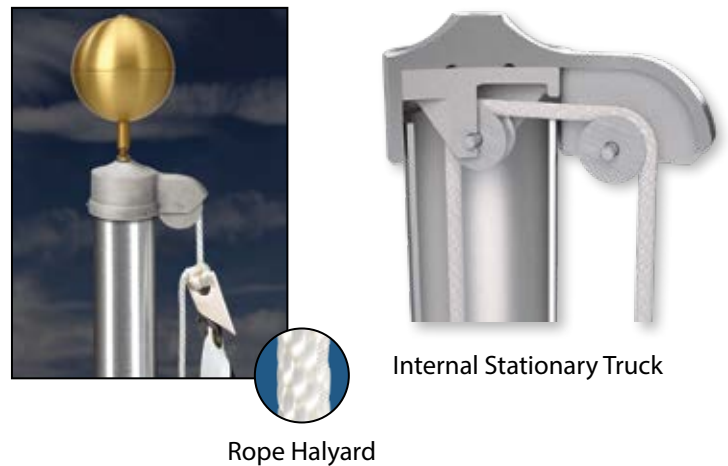

Rope Halyard

Internal Stationary Truck

External Halyard Systems

External Halyard Systems utilize flagpole Trucks with an exposed Pulley, Rope Halyard and Flagpole Cleat. Truck options include Single Stationary, Single Revolving and Double Revolving.

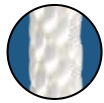
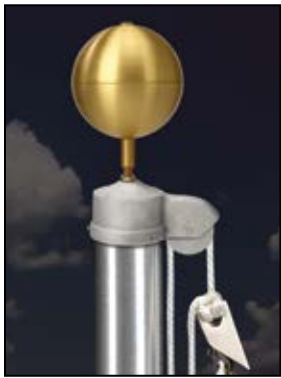

Rope Halyard



External Stationary Truck



Ornament

External Truck

Rope Halyard

Flagsnap and
Flagsnap Cover

Cleat

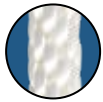

Rope Halyard



External Single Revolving Truck

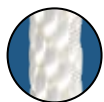

Rope Halyard



External Double Revolving Truck

The External Double Revolving Truck is available as an option on all External Halyard flagpoles.

Flagpole Design Shaft Descriptions and Options

See Page 17 For Additional Information on Part Number Descriptions.

Mounting Height

The Mounting Height of flagpoles offered by Concord American Flagpole refers to the exposed height above grade and is measured to the top of the of the flagpole shaft.* When truck and ornaments are added, overall height can be greater by 1'-2', which can be relevant in areas with height ordinances. Upon request and at no additional charge, Mounting Heights can be shortened to achieve the desired overall height.

*NOTE: See 25' Mounting Height Exception.

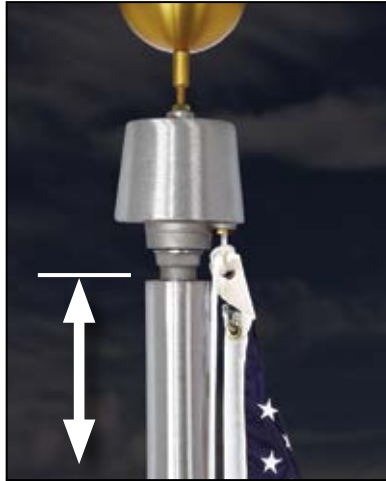

Mounting Height

25' Mounting Height Exception

Standard Ground Set Flagpoles offered in 25' Mounting Heights are manufactured in a single piece with an overall length of 26'-6". Below grade 2'-6" will be inserted into the Ground Sleeve. When the truck and finial are attached, the nominal height of the completed flagpole will be 25'. This industry accepted standard allows shipping in a pup trailer at a significant freight savings. Full 27'-6" shafts are available upon request.

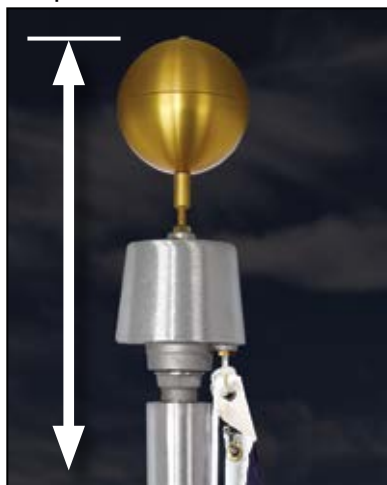

25' Nominal Mounting Height

Top Diameter and Butt Diameter

The Top Diameter is measured in inches at the very top of the shaft. Butt Diameter is measured in inches at the base of the shaft.

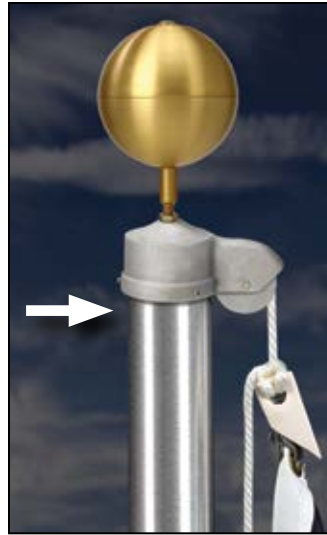

Top Diameter



Butt Diameter

Single & Multi-Piece Flagpole Shafts

Concord American Flagpole offers flagpoles in both single and multi-piece designs. Single piece flagpoles are offered in Mounting Heights up to 40' (44' overall length), combining ease of installation with superior aesthetics. 30'-40' flagpoles are also available in a 2-Piece option, providing the perfect solution when freight costs or jobsite locations are a deciding factor. Flagpoles 45' and larger will contain multiple piece shafts based on Mounting Height. Sections can be easily field assembled without any loss of structural integrity, leaving only a hairline joint to indicate that the shaft is not a single piece flagpole.

Wall Thickness

Wall Thickness of Concord American Flagpoles are measured in inches, with Commercial flagpoles varying from .125" to .500".



Ball Truck

A Concord American Flagpole exclusive, the Ball Truck replaces the traditional truck and ball finial by combining the function of the truck assembly with the ornamental features of a ball finial.

Available in both Internal and External options, these heavy-duty, sealed bearing designs offer Architects, Specifiers and Project Owners a unique and durable truck assembly option.

See Pages 65 and 68 for additional information.



Ball Truck

Replaces Traditional Truck and Finial Design

Traditional Truck and Finial Design

Ornaments

Concord American Flagpole's offering of ornaments is unequaled in the industry for both quality and selection. From our patented heavy-duty Flagpole Ball, a standard on all of our commercial flagpoles, to specialty Balls, Finials, and Eagles. Our Ornaments deliver both aesthetics and unmatched reliability, providing the perfect finishing touch to any flagpole.

See Pages 58-61 for additional information.



Collar Options

Unlike many competitors, all commercial flagpoles from Concord American Flagpole include a 1-Piece Aluminum Collar as a standard. 1-Piece and 2-Piece Collars in Spun Aluminum and our industry-exclusive, 1/4" thick heavy-duty Cast Aluminum designs are available for upgrade and replacement options.

See Pages 80-81 for additional information.



Spun and Cast Aluminum Designs



1-Piece and 2-Piece Options

Halyard Security

Cleat Cover Assemblies, Halyard Cover Assemblies, and Halyard Security Kits (*combining the Cleat and Halyard Covers*) provide tamper resistant security for External Halyard flagpoles.

See Page 77 for additional information.

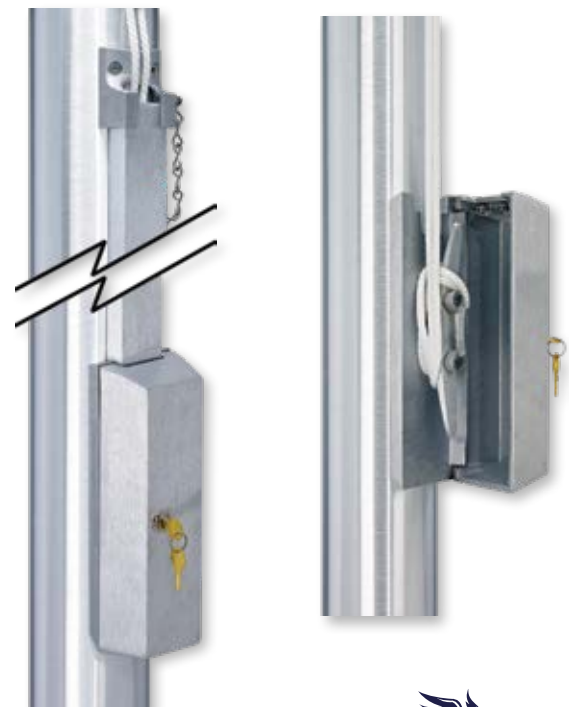

100' Flagpole

APEX™ IRW Independence Series
Internal Reinforced with Winch - Wire
Halyard
See Page 40

Concord American Flagpole's Expert Engineering Design and World-Class Manufacturing Capabilities have led to the development of another industry

first... a 100' Aluminum Flagpole* in a 12" Butt Diameter.

- The advantages of aluminum when compared to steel alternatives are substantial.
- Aluminum is Corrosion Resistant, Lightweight, and provides Lower Overall Cost of Ownership.
- Additionally, our 12" Butt Diameter Design significantly lowers installation costs when compared to competitor's 16"+ Butt Diameter Aluminum Flagpoles.

Standard Specifications

- 12" Butt Diameter, .500" Wall Thickness
- Heavy-Duty Custom 24" Ball Truck with Stainless Steel Spindle
- Extra-Large Flying Eagle
- Complete Internal Wire Halyard Cable Assembly with Heavy-Duty Flag Arrangement (20' x 30')

Custom Downlighting Flagpole Options are available for 100' IRW Flagpoles.



24" Heavy-Duty Internal Ball Truck and Extra-Large Flying Eagle are Standard on 100' Flagpoles.

**100'
Nominal
Height
To Top Of
Eagle**

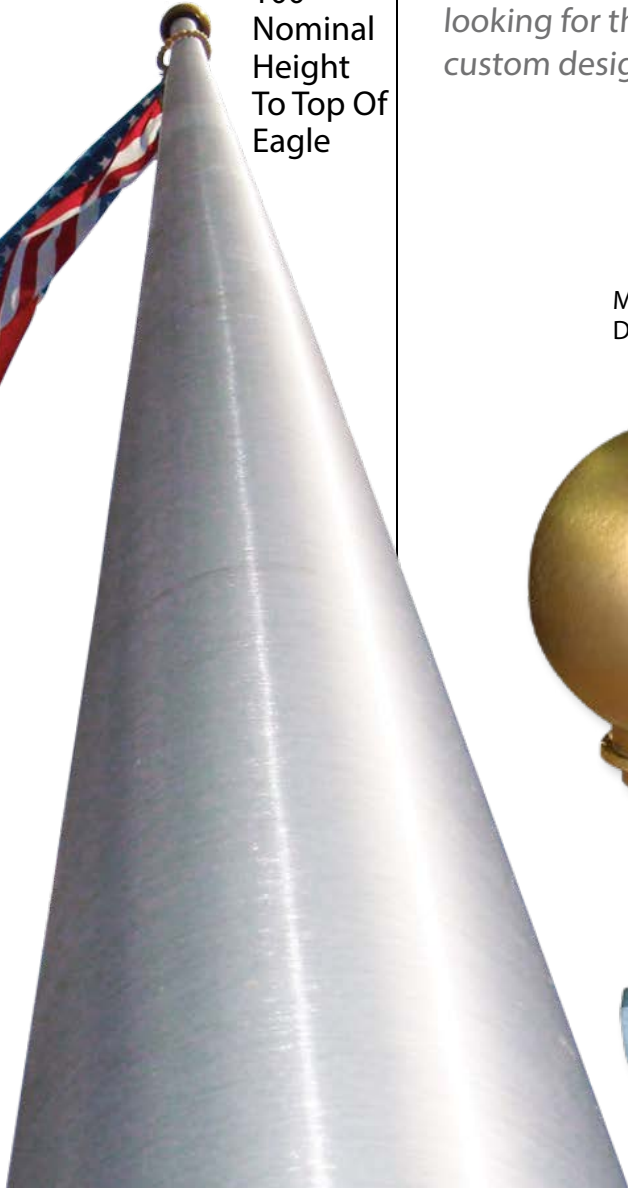

Custom and Specials Capabilities

Long recognized as a leader in innovative design, Concord American Flagpole's unique role within an integrated supply chain provides unsurpassed Engineering and Manufacturing capabilities for projects with unique and custom specifications. Our abilities are almost limitless.

- Banner Poles
- Flagpoles Incorporating Decorative Bases
- Entasis Tapered Flagpoles
- Mega Truck Applications *(See Page 64)*
- Oversized Flagpole Balls and Eagles *(See Pages 59 & 61)*
- Hinged Flagpoles

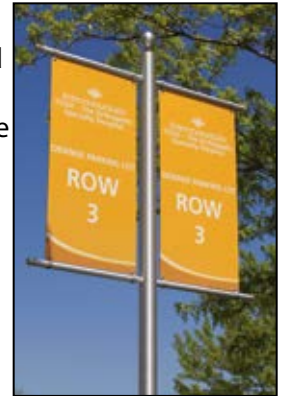

We deliver custom solutions to design professionals and project owners looking for that truly custom design.



Multiple Decorative Base Design Options Available

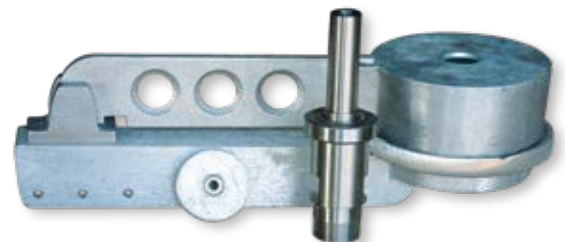
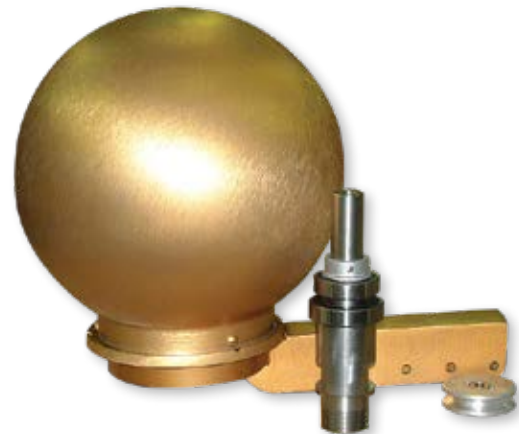

Cone Tapered and Entasis Tapered Flagpoles
 Concord American Flagpole's standard aluminum flagpoles are designed and manufactured in a Cone Taper. This design consists of a lower, non-tapered portion of the flagpole (*length varies by flagpole height*) followed by a straight taper which extends to the top of the shaft.

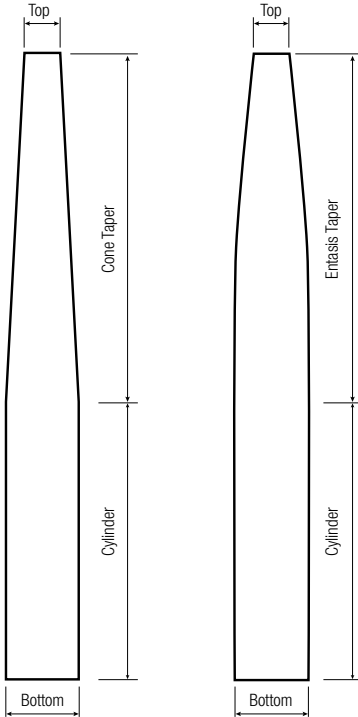

Standard Cone Tapered Flagpole Entasis Tapered Flagpole

Some schools of architecture hold that a building column...or a flagpole...with a standard conical taper might appear to curve inward when viewed against the light of the sky. To counteract this illusion, early architects devised the technique of curving the taper gently outward to create a pleasing and a nearly perfect appearance. This taper is commonly referred to as an Entasis Taper, and is most widely recognized for its use on columns found on the Parthenon. *An Entasis Taper is available in all Concord American Flagpole standard flagpole designs. Contact Customer Service for additional information.*



Internal Halyard Winch System Diagram

The diagram below identifies the components used in a Wire Cable Based Internal Halyard Flagpole. *See Pages 72-73 for more information on Wire Cable Based Internal Halyard components. Note: Rope Based Internal Halyard Flagpoles do not require Cable Assemblies and Flag Arrangements. See Page 71 for more information on Rope Based Internal Halyard components.*

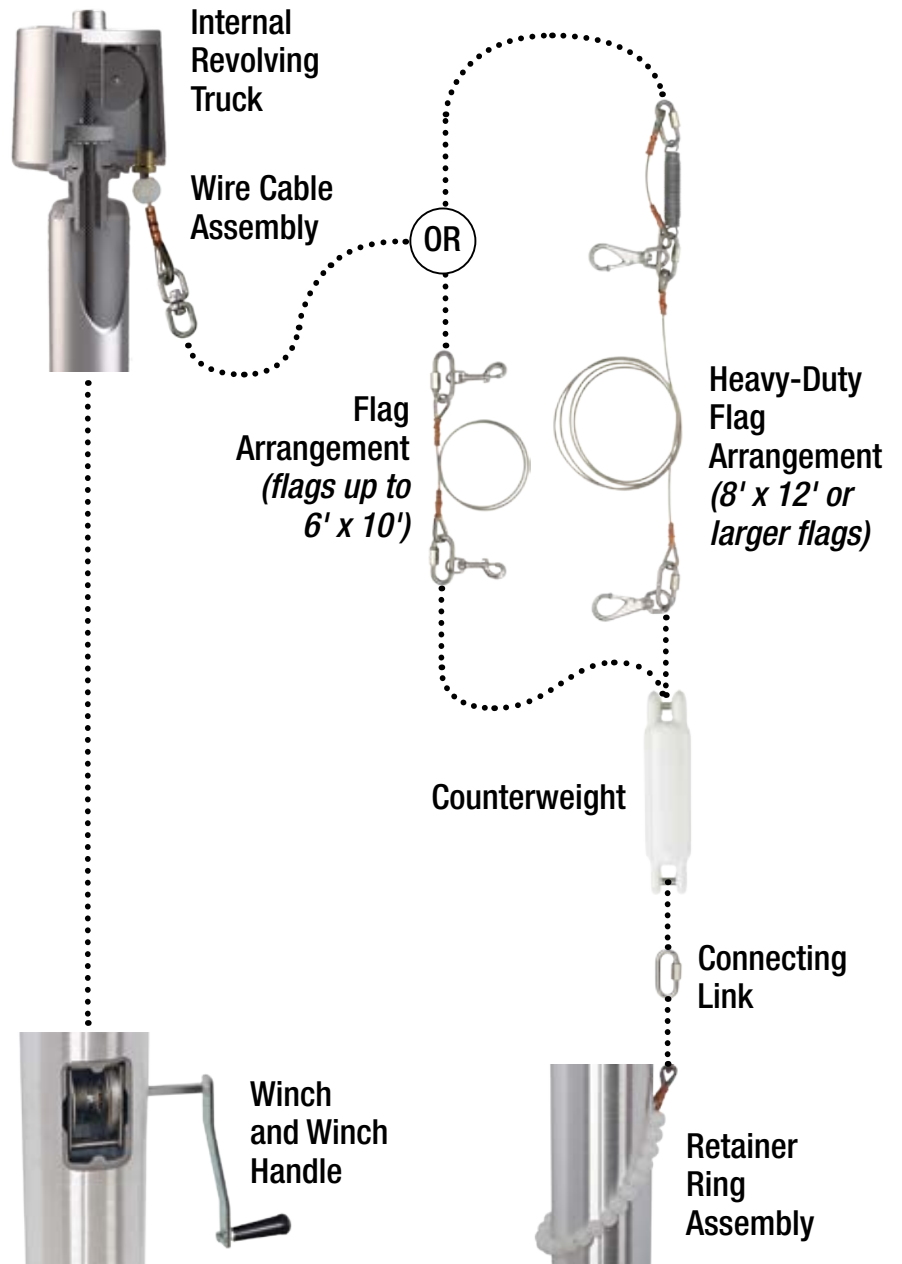

Architectural Specification Assistance
 Concord American Flagpole offers a broad range of tapered aluminum flagpoles that are included in virtually all architectural specification guides. Written specifications and specification drawings can be downloaded online at www.concordamericanflagpole.com. Should you need assistance with the selection of flagpoles for a specific application, please contact Customer Service.



Designing Your Flagpole – Foundation Options

Installation methods available to securely and permanently mount the flagpole include Ground Set and Shoe Base options.

Ground Set

Ground Set installations are the strongest and most common form of flagpole installation. They require burial of the flagpole shaft in a concrete foundation to a depth equal to 10% of the mounting height.

All standard Flagpoles listed in this catalog are designed for Ground Set foundations.

Each flagpole is shipped at 10% over listed Mounting Height. (See Page 10 for 25' mounting height exception.)

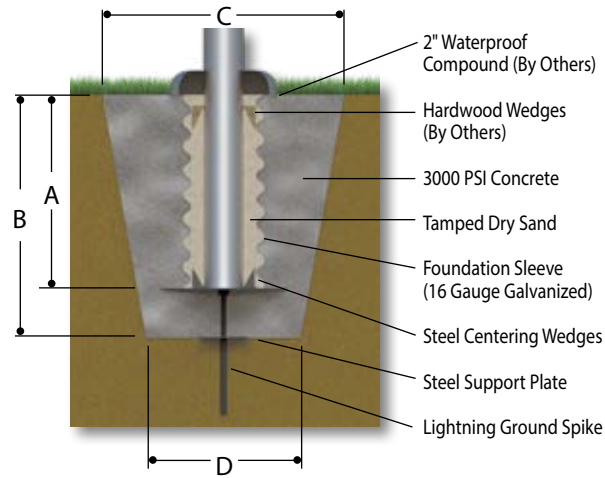

NAAMM's Metal Flagpole Manual offers basic suggestions on foundation measurements in firm, dry soil only using dry tamped sand and 3000 PSI concrete. Soil conditions vary by site. Exact foundation requirements should be verified by a Structural Engineer with knowledge of soil conditions in your locality.

EXPOSED MOUNTING HEIGHT	Ground Set			
	A	B	C	D
20'-0"	2'-0"	2'-6"	30"	24"
25'-0"	2'-6"	3'-0"	36"	24"
30'-0"	3'-0"	3'-6"	36"	24"
35'-0"	3'-6"	4'-0"	36"	30"
40'-0"	4'-0"	4'-6"	45"	36"
45'-0"	4'-6"	5'-0"	45"	36"
50'-0"	5'-0"	5'-6"	50"	42"
60'-0"	6'-0"	6'-6"	60"	48"
70'-0"	7'-0"	7'-6"	60"	48"
80'-0"	8'-0"	8'-6"	72"	48"
95'-0"	9'-6"	10'-0"	72"	48"

Shoe Base

Shoe Base installations are typically used when an above ground installation is required.

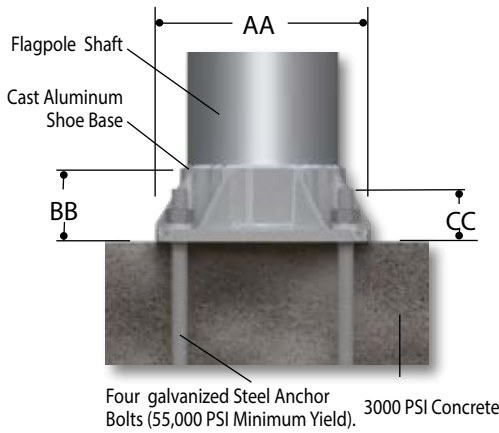

Four galvanized Steel Anchor Bolts (55,000 PSI Minimum Yield), 3000 PSI Concrete

All Shoe Base Flagpoles are heat treated after weld to T-6 temper.

BUTT DIA.	AA BASE SQUARE	BBB BASE HEIGHT	CCC BOLT PROJECTION	BOLT DIAMETER	BOLT CIRCLE DIAMETER	LIST PRICE ADDER
4"	7-1/2"	3"	2"	3/4"	6-1/2"-8	\$246
5"	7-1/2"	3"	2"	3/4"	7-1/2"-8	\$246
6"	9-3/4"	3-1/2"	2-3/4"	1"	9"-10"	\$304
7"	10-1/2"	3-11/16"	2-3/4"	1"	10"-11"	\$304
8"	11-1/4"	3-15/16"	2-3/4"	1"	11"-12"	\$304
10" Up To .250	14"	4-7/8"	3-1/4"	1"	14"-15"	\$608
10" .312 & Larger	14"	4-7/8"	3-1/4"	1-1/4"	14"-15"	\$608
12"	17"	8"	3-3/4"	1-1/4"	16"-18"	\$1,209

All 20' to 80' Flagpoles listed in this catalog with a 4"+ Butt Diameter can be provided in a Shoe Base Installation option. List price of a Shoe Base Flagpole can be obtained by adding the appropriate List Price Shoe Base Adder to the List Price of the flagpole.

Contact Concord American Flagpole Customer Service for Wind Speed information for your particular design.

Designing Your Flagpole – Flagpole Height

The next consideration in choosing your flagpole design is to determine the mounting height. This can be specified solely on the required aesthetics of the particular job, or can be determined by the size of the flag wished to be flown.

The National Association of Architectural Metal Manufacturers (NAAMM) publishes the following criteria for determining the maximum flag size for each flagpole height.

Ground Set		Wall Mounted		Outrigger	
FLAGPOLE HEIGHT	FLAG SIZE	FLAGPOLE HEIGHT	FLAG SIZE	FLAGPOLE HEIGHT	FLAG SIZE
15'	3' x 5'	12' to 15'	4' x 6'	8'	3' x 5'
20'	4' x 6'	20' to 25'	5' x 8'	10' to 12'	4' x 6'
25'	5' x 8'	30' to 35'	6' x 10'	13' to 16'	5' x 8'
30'	6' x 10'	40' to 45'	8' x 12'	17' to 23'	6' x 10'
35'	6' x 10'				
40'	8' x 12'				
45'	8' x 12'				
50'	10' x 15'				
60'	12' x 18'				
70'	12' x 18'				
80'	15' x 25'				

Safety Note: Extreme care must be exercised when installing flagpoles near overhead power lines or when digging in the vicinity of buried utilities.

Caution: During installation, extreme care should be taken to insure that all components are securely attached.

Flagpole Specifications - Wind Speed

With the height of the flagpole determined, choosing the correct flagpole design next requires the knowledge of the Wind Loads to which the flagpole will be subjected. Concord American Flagpole Engineers, working with specifications contained in The National Association of Architectural Metal Manufacturers' (NAAMM) Guide Specifications For Design Of Metal Flagpoles (ANSI/NAAMM FP 1001-07), have determined the Maximum Wind Speed for both Nylon Flagged and Unflagged flagpoles using Ground Set Installations.

STD. FLAG SIZE	MAX WIND SPEED	MAX WIND SPEED
	WITH NYLON FLAG	NO FLAG
4' x 6'	109	147
4' x 6'	136	229
4' x 6'	160	262
	182	



Sample Wind Speed Chart

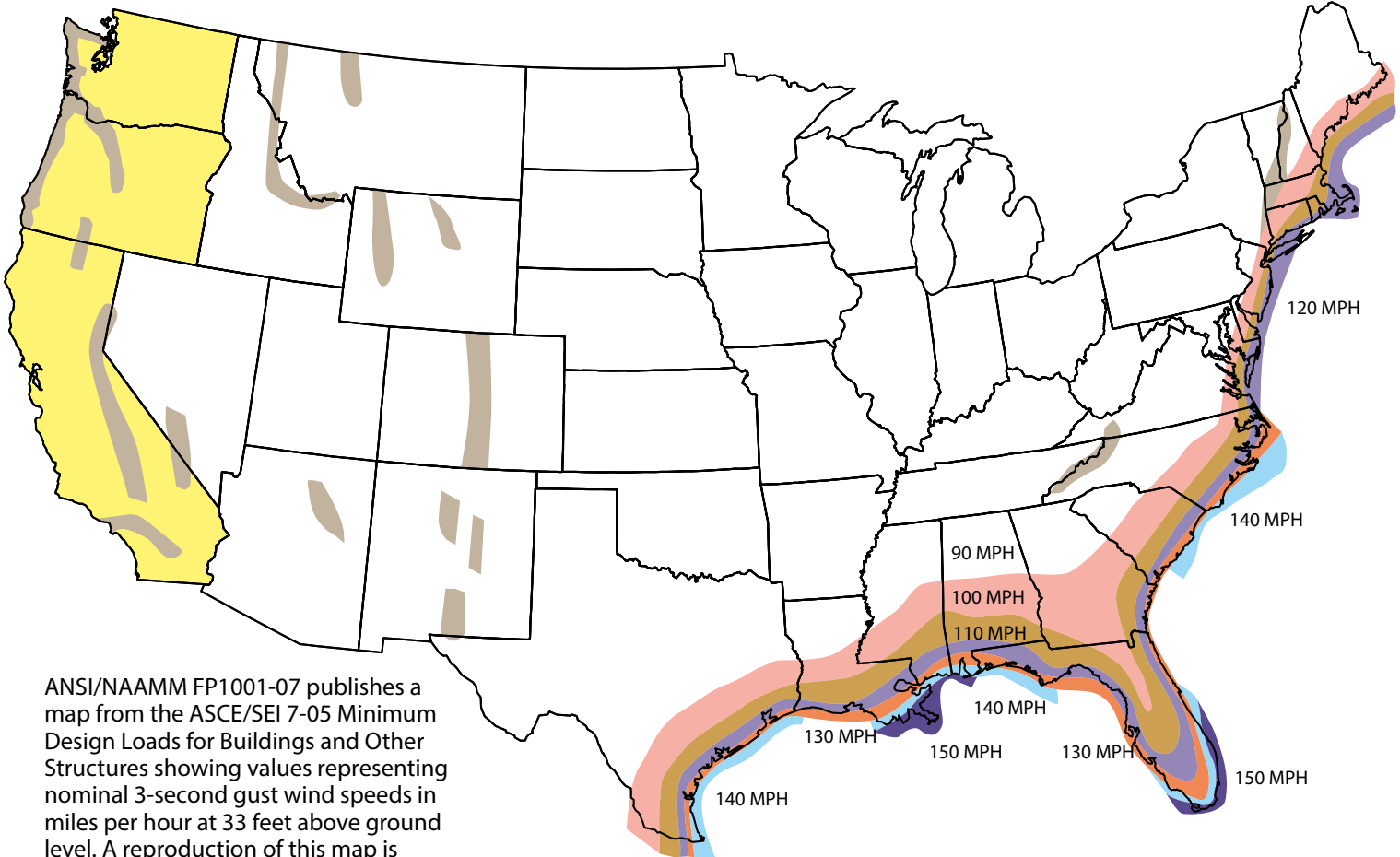

ANSI/NAAMM FP1001-07 publishes a map from the ASCE/SEI 7-05 Minimum Design Loads for Buildings and Other Structures showing values representing nominal 3-second gust wind speeds in miles per hour at 33 feet above ground level. A reproduction of this map is provided and should be used to specify the proper flagpole for your application. Please note that Special Wind Zone Areas, including but not limited to mountainous terrain, gorges, and ocean promontories, should be examined for unusual wind conditions. (See page 89)

All Wind Speeds listed in Flagpole Product Tables are for Ground Set Installations flying a Nylon flag in the NAAMM recommended size listed. See Pages 90-92 Flagpole Windspeed Charts for additional calculations for Polyester Flags, Double Nylon Flags and Flags one size smaller than the NAAMM recommended maximum size. Contact Concord American Flagpole for Wind Speed information on Shoe Base installations, exceeding the maximum NAAMM recommended flag size for flagpole height chosen, installation on rooftops, or for flying multiple flags in sizes or materials not listed in the Chart.

Wind Speeds - Other Regions

LOCATION	MPH	(M/S)
Hawaii	105	(47)
Puerto Rico	145	(65)
Guam	170	(76)
Virgin Islands	145	(65)
American Samoa	125	(56)
Alaska*	90-130	(40-58)

- 85 MPH
- 90 MPH
- 100 MPH
- 110 MPH
- 120 MPH
- 130 MPH
- 140 MPH
- 150 MPH
- Special Wind Region

Safety Note: The specification and installation of a flagpole with wind speed ratings that do not meet the maximum wind speed for the project location, or flagpoles flying flags and banners that exceed the NAAMM recommended flag size, can result in personal injury and/or property damage. Flags should always be removed from the flagpole during severe weather events.



Designing Your Flagpole – Finish Options

Concord American Flagpole is the industry's unsurpassed leader in finish options.

Satin Finish

Concord American Flagpole's aluminum flagpoles are constructed of Aluminum Alloy 6063, a marine grade alloy that exhibits extremely high resistance to corrosion. On contact with air, Aluminum forms a resistant layer of aluminum oxide. This process naturally guards against corrosion, allowing our flagpoles to be left unfinished while ensuring a lifetime of aesthetic beauty.

Concord American Flagpole's Satin Aluminum Finish is achieved in a multi-pass, mechanical rotary sanding operation utilizing specially formulated abrasives. This attention to detail ensures a consistent, brushed aluminum finish that has become the industry's first choice for low-maintenance and enduring flagpole finishes.



SAT - Satin Aluminum Finish



Powder Coat Finish

Concord American Flagpole combines state-of-the-art, on-site Powder Coating operations with the highest quality polyester thermoset powders.

Standard Colors



BZT - BronzeTone



BLK - Black



CLR - Clear



WHT - White

Unlimited Color Options

Simply provide an RAL color number or color chip sample and Concord American Flagpole can provide the perfect Powder Coat Color for your next project.



Watch our video on finishes for a more detailed explanation



Anodized Finish

Concord American Flagpole offers standard Anodized flagpole finishes in Clear, Dark Bronze and Black. Exacting manufacturing specifications enhance the anodizing process, ensuring Concord American Flagpole customers the optimum color and longevity in colored Anodized finishes.



ACL - Clear



ADB - Dark Bronze



ABL - Black

Specialty Finish Options

Concord American Flagpole now offers durable powder coat finishes designed to accurately replicate wood grain and camouflage on aluminum flagpoles.



Oak Woodgrain

Flagpole Catalog Number Description

Products are identified by the Design, Exposed Mounting Height, Wall Thickness, Butt Diameter, Shaft Section, and Finish. *Custom designs are available. See Page 12 for more information.*

Catalog Number Example (ESR30B51-SAT)

DESIGN	EXPOSED HEIGHT	WALL THICKNESS	BUTT DIAMETER	SHAFT SECTIONS	FINISH
ESR	30	C	6	1	SAT

ESR = External Single Revolving,
 30 = 30 foot Mounting Height,
 C = 0.156" Wall Thickness,
 6 = 6" Butt Diameter,
 1 = One-Piece Ground Set Shaft,
 SAT = Satin Brushed Aluminum Finish

Design		Height		Wall Thickness		Butt Diameter		Shaft Selections		Finish	
CODE	DESCRIPTION	CODE	LENGTH	CODE	WALL THICKNESS	CODE	BUTT DIA.	CODE	SHAFT TYPE	CODE	DESCRIPTION
ESS	External Single Stationary	10	10 foot	P	0.065 inches	B	2 inches	1	1-piece, Ground Set	SAT	Satin Aluminum
ESR	External Single Revolving	12	12 foot	T	0.080 inches	D	2.5 inches	2	2-piece, Ground Set	ACL	Anodized - Clear
EDR	External Double Revolving	15	15 foot	B	0.125 inches	3	3 inches	3	3-piece, Ground Set	ADB	Anodized - Dark Bronze
XESR	Xtreme External Single Revolving	20	20 foot	C	0.156 inches	F	3.5 inches	4	4-piece, Ground Set	ABL	Anodized - Black
ICC	Internal Cam Cleat	25	25 foot	D	0.188 inches	4	4 inches	M	1-piece, Shoe Base	BZT	Powder Coat - BronzeTone
ISC	Internal Sentry Cam Cleat	30	30 foot	E	0.219 inches	5	5 inches	N	2-piece, Shoe Base	BLK	Powder Coat - Black
IRC	Internal Reinforced with Cam Cleat	35	35 foot	F	0.250 inches	6	6 inches	P	3-piece, Shoe Base	WHT	Powder Coat - White
IWW	Internal With Winch	40	40 foot	G	0.312 inches	7	7 inches	Q	4-piece, Shoe Base	CLR	Powder Coat - Clear
ISW	Internal Sovereignty Winch	45	45 foot	H	0.375 inches	8	8 inches			XXX	Powder Coat - (Specify)
IRW	Internal Reinforced with Winch	50	50 foot	I	0.500 inches	9	9 inches				
XIWW	Xtreme Internal With Winch	55	55 foot			1	10 inches				
XIRW	Xtreme Int. Reinforced w/Winch	60	60 foot			2	12 inches				
NSM	Nautical Single Mast	65	65 foot								
NDM	Nautical Double Mast	70	70 foot								
O**	Outrigger Series (**Specify Bracket)	75	75 foot								
V**	Vertical Series (**Specify Bracket)	80	80 foot								
VIC	Vertical Internal Cam Cleat										
VIW	Vertical Internal Winch										
ATK	American Tradition Kit										
PAT	American Spirit Kit										

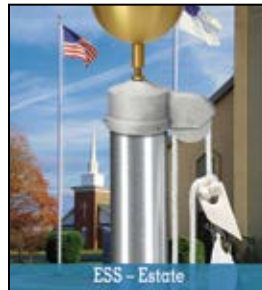

PAGE 18



PAGE 20



PAGE 22



PAGE 24



PAGE 26



PAGE 28



PAGE 30



PAGE 32

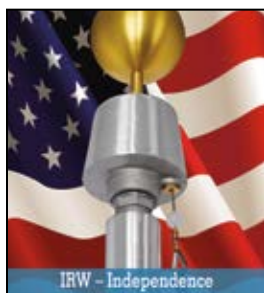

PAGE 34

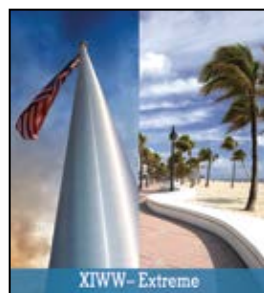

PAGE 36



PAGE 38



PAGE 42



PAGE 44



PAGE 46



PAGE 48



PAGE 50



PAGE 51



PAGE 52-55

Estate Series - ESS

External Single Stationary - Rope Halyard

The Estate Series from Concord American Flagpole provides commercial grade flagpoles that are a perfect fit for budget minded projects. Manufactured to the same quality standards as our Continental Series, our Estate Series offers flagpoles with heights from 15' to 35' which are ideal for residential homes, small businesses and commercial complexes.

STANDARD FLAGPOLE ACCESSORIES - 3" TO 5" BUTT DIAMETERS

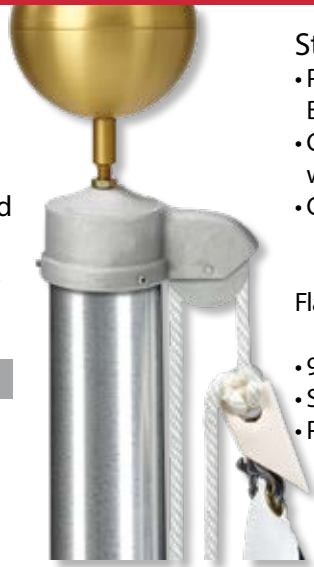

Standard Specifications

- Patented, Heavy-Duty Gold Anodized Aluminum Ball
- Cast Aluminum Single Stationary Truck Assembly with Aluminum Pulley
- Complete External Halyard Assembly
 - Rope Halyard - 5/16" #10 Polyester
 - Two (2) Nickel Plated Cast Zinc Swivel
- Flagsnaps
 - Two (2) Neoprene Flagsnap Covers
- 9" Cast Aluminum Cleat
- Spun Aluminum FC-11 Flash Collar
- PVC Ground Sleeve

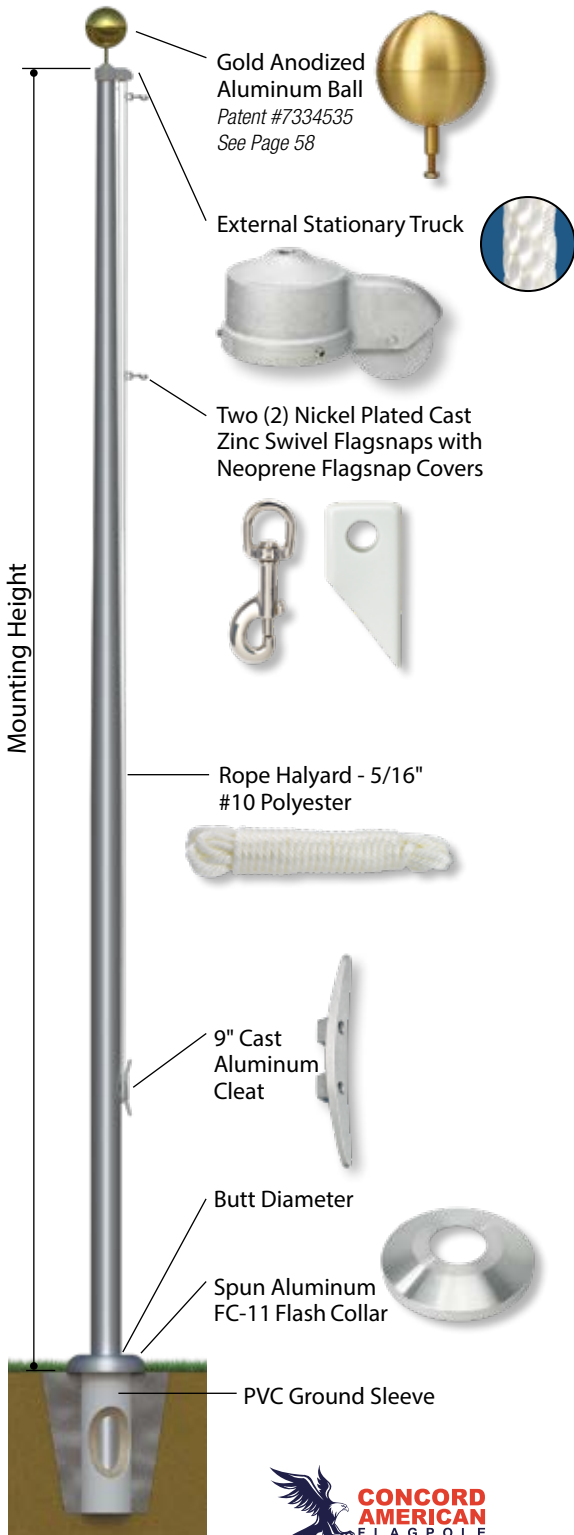

Estate Series - ESS External Single Stationary - Rope Halyard

MTG HGT.	BUTT DIA.	WALL THICKNESS	POLE SECTIONS	SET DEPTH	TOP DIAM.	STD FLAG SIZE	MAX WIND SPEED WITH NYLON	MAX WIND SPEED NO FLAG	CATALOG NUMBER ***SPECIFY FINISH	Satin	CLEAR ANODIZED	DARK BRONZE OR BLACK ANODIZED	BRONZE TONE, BLACK, WHITE, OR CLEAR POWDERCOAT
15'	3"	.125"	1	2'-0"	2"	3' x 5'	113	149	ESS15B31-***	\$693	\$853	\$891	\$838
20'	3"	.125"	1	2'-0"	2"	4' x 6'	83	108	ESS20B31-***	\$810	\$1,003	\$1,052	\$997
	4"	.125"	1	2'-0"	3"	4' x 6'	109	147	ESS20B41-***	\$1,215	\$1,493	\$1,556	\$1,414
	5"	.125"	1	2'-0"	3"	4' x 6'	136	229	ESS20B51-***	\$1,512	\$1,859	\$1,938	\$1,796
	5"	.156"	1	2'-0"	3"	4' x 6'	160	262	ESS20C51-***	\$1,683	\$2,057	\$2,136	\$1,967
	5"	.188"	1	2'-0"	3"	4' x 6'	182	287	ESS20D51-***	\$1,975	\$2,396	\$2,475	\$2,259
25'	3"	.125"	1	2'-6"	2"	5' x 8'	63	83	ESS25B31-***	\$968	\$1,200	\$1,259	\$1,194
	4"	.125"	1	2'-6"	3"	5' x 8'	83	106	ESS25B41-***	\$1,347	\$1,663	\$1,740	\$1,587
	5"	.125"	1	2'-6"	3"	5' x 8'	98	136	ESS25B51-***	\$1,766	\$2,175	\$2,271	\$2,109
	5"	.156"	1	2'-6"	3"	5' x 8'	111	178	ESS25C51-***	\$2,081	\$2,540	\$2,636	\$2,424
	5"	.188"	1	2'-6"	3"	5' x 8'	124	209	ESS25D51-***	\$2,623	\$3,169	\$3,265	\$2,966
30'	4"	.125"	1	3'-0"	3"	6' x 10'	66	85	ESS30B41-***	\$1,693	\$2,088	\$2,183	\$1,991
	4"	.125"	2	3'-0"	3"	6' x 10'	66	85	ESS30B42-***	\$1,749	\$2,153	\$2,248	\$2,047
	5"	.125"	1	3'-0"	3"	6' x 10'	78	96	ESS30B51-***	\$1,949	\$2,418	\$2,536	\$2,375
	5"	.125"	2	3'-0"	3"	6' x 10'	78	96	ESS30B52-***	\$2,121	\$2,617	\$2,736	\$2,547
	5"	.156"	1	3'-0"	3"	6' x 10'	86	112	ESS30C51-***	\$2,387	\$2,926	\$3,044	\$2,813
	5"	.156"	2	3'-0"	3"	6' x 10'	86	112	ESS30C52-***	\$2,469	\$3,021	\$3,139	\$2,895
	5"	.188"	1	3'-0"	3"	6' x 10'	94	131	ESS30D51-***	\$2,751	\$3,348	\$3,467	\$3,177
	5"	.188"	2	3'-0"	3"	6' x 10'	94	131	ESS30D52-***	\$2,833	\$3,443	\$3,562	\$3,259
35'	5"	.156"	1	3'-6"	3"	6' x 10'	73	87	ESS35C51-***	\$2,464	\$3,041	\$3,179	\$2,960
	5"	.156"	2	3'-6"	3"	6' x 10'	73	87	ESS35C52-***	\$2,510	\$3,094	\$3,233	\$3,006
	5"	.188"	1	3'-6"	3"	6' x 10'	79	95	ESS35D51-***	\$2,995	\$3,657	\$3,795	\$3,491
	5"	.188"	2	3'-6"	3"	6' x 10'	79	95	ESS35D52-***	\$3,237	\$3,938	\$4,076	\$3,733

*** - Finish Options

- SAT = Satin
- ACL = Anodized - Clear
- ADB = Anodized - Dark Bronze
- ABL = Anodized - Black
- BZT = Powder Coat - BronzeTone
- BLK = Powder Coat - Black
- WHT = Powder Coat - White
- CLR = Powder Coat - Clear

Quantity Discounts

- 5+ = 5%
- 8+ = 10%
- 15+ = 12%
- *Flagpoles From All Flagpole Series May Be Combined To Achieve Quantity Discounts.

ESTATE SERIES - ESS OPTIONS

Cap Mounted Style Single Revolving Truck In Lieu Of Standard Stationary Truck.



See Page 64 Add \$67

Cast Aluminum FC-11 Collar In Lieu of Spun Collar - See Page 81.



3"-5" Butt Diameters Add \$67

Cleat Cover (Specify Cylinder Lock or Padlock) - See Page 77.

3"-4" Butt Diameters Add \$128

5" Butt Diameters Add \$158



Cleat Cover Box with 5' Halyard Cover (Specify Cylinder Lock or Padlock) - See Page 77.

3"-4" Butt Diameters Add \$243

5" Butt Diameters Add \$305



Hinge Base Mount
- to be used on 1-piece, external poles, up to 25'

4"-5" Butt Diameters Add \$272

Shoe Base Designs for Surface Mount Installations are available in 4" and 5" Estate Series – ESS Flagpoles. See Page 14.
4"-5" Butt Diameters Add \$246

Flagpole Lighting Options are available for all Estate Series Flagpoles – See Pages 84-91.



Continental Series - ESR

External Single Revolving - Rope Halyard

The Continental Series from Concord American Flagpole combines heavy-duty aluminum flagpoles in 20' to 80' mounting heights with the highest quality hardware available to the industry today. These flagpoles meet the most stringent architectural standards and are certain to enhance the landscape of any business or industrial property.

STANDARD FLAGPOLE ACCESSORIES - 4" TO 8" BUTT DIAMETERS

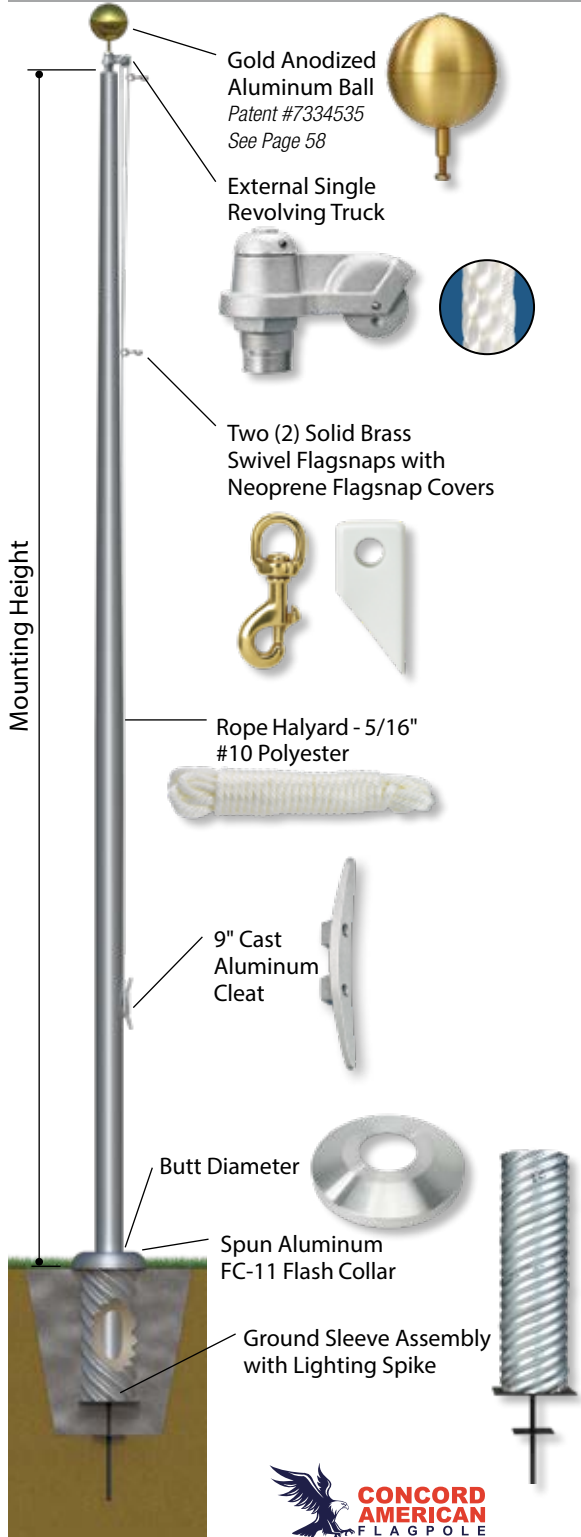

Shoe Base Designs for Surface Mount Installations are available with Continental Series – ESR Flagpoles. See Page 14.

- 4"-5" Butt Diameters Add \$246
- 6"-8" Butt Diameters Add \$304
- 10" Butt Diameters Add \$608
- 12" Butt Diameters Add \$1,209

Standard Specifications

- Patented, Heavy-Duty Gold Anodized Aluminum Ball
- Cast Aluminum Revolving Truck with Dual Stainless Steel Bearing Assemblies, Aluminum Pulley and Aluminum Spindle
- Complete External Halyard Assembly
 - Rope Halyard - 5/16" #10 Polyester
 - Two (2) Solid Brass Swivel Flagnaps
 - Two (2) Neoprene Flagnap Covers
- 9" Cast Aluminum Cleat
- Spun Aluminum FC-11 Flash Collar
- Galvanized 16-Gauge Corrugated Steel Ground Sleeve with Steel Grounding Spike

Standard Upgrades – 10" and 12" Butt Diameters

- Heavy-Duty Truck with Dual SEALED Bearing Assemblies
- Rope Halyard - Heavy-Duty 3/8" #12 Polyester
- Two (2) Heavy-Duty Brass Flagnaps with Covers
- Heavy-Duty 5/8" Ball Stem
- Heavy-Duty Cast Aluminum Collar

CONTINENTAL SERIES - ESR OPTIONS

Double Revolving System
 (Double Truck, Extra Cleat and Complete Double Halyard Assembly) – Specify EDR (External Double Revolving).
 See Page 63 Add \$67

Heavy-Duty Truck with Dual SEALED Bearings for 4"-8" Butt Diameter Flagpoles
 See Page 63 Add \$140

Cast Aluminum, SEALED Bearings, Gold Powder Coated Ball Truck
 Replaces Standard Truck and Ball Combination - See Page 65.

8" Diameter Ball/Truck Add \$164

Cleat Cover Box (Specify Cylinder Lock or Padlock).
 See Page 77 Add \$158

Cleat Cover Box with 5' Halyard Cover (Specify Cylinder Lock or Padlock) - See Page 77.
 5"-6" Flagpole Butt Diameters...Add \$305
 7"-12" Flagpole Butt Diameters..Add \$364

Cast Aluminum FC-11 Collar In Lieu of Spun Collar - See Page 81.
 5"-7" Butt Diameters Add \$67
 8"-12" Butt Diameters Add \$201

Hinge Base Mount
 to be used on 1-piece, external poles, up to 25'
 4"-5" Butt Diameters Add \$272

Flagpole Lighting Options are available for all Continental Series ESR Flagpoles – See Pages 84-91.



Continental Series - ESR External Single Revolving - Rope Halyard

MTG HGT.	BUTT DIA.	WALL THICKNESS	POLE SECTIONS	SET DEPTH	TOP DIAM.	STD FLAG SIZE	MAX WIND SPEED WITH NYLON	MAX WIND SPEED NO FLAG	CATALOG NUMBER ***SPECIFY FINISH	Satin	CLEAR ANODIZED	DARK BRONZE OR BLACK ANODIZED	BRONZE TONE, BLACK, WHITE, OR CLEAR POWDER COAT
20'	4"	.125"	1	2'-0"	3"	4' x 6'	109	147	ESR20B41-***	\$1,359	\$1,660	\$1,723	\$1,558
	5"	.125"	1	2'-0"	3"	4' x 6'	136	229	ESR20B51-***	\$1,869	\$2,273	\$2,352	\$2,153
	5"	.156"	1	2'-0"	3"	4' x 6'	160	262	ESR20C51-***	\$2,082	\$2,520	\$2,599	\$2,366
	5"	.188"	1	2'-0"	3"	4' x 6'	182	287	ESR20D51-***	\$2,363	\$2,846	\$2,925	\$2,647
	6"	.156"	1	2'-0"	3.5"	4' x 6'	208	301	ESR20C61-***	\$2,510	\$3,038	\$3,132	\$2,842
	6"	.188"	1	2'-0"	3.5"	4' x 6'	229	328	ESR20D61-***	\$3,152	\$3,783	\$3,876	\$3,484
25'	4"	.125"	1	2'-6"	3"	5' x 8'	83	106	ESR25B41-***	\$1,479	\$1,816	\$1,892	\$1,719
	5"	.125"	1	2'-6"	3"	5' x 8'	98	136	ESR25B51-***	\$2,032	\$2,483	\$2,578	\$2,374
	5"	.156"	1	2'-6"	3"	5' x 8'	111	178	ESR25C51-***	\$2,403	\$2,913	\$3,009	\$2,745
	5"	.188"	1	2'-6"	3"	5' x 8'	124	209	ESR25D51-***	\$2,905	\$3,496	\$3,591	\$3,247
	6"	.156"	1	2'-6"	3.5"	5' x 8'	149	230	ESR25C61-***	\$3,004	\$3,637	\$3,750	\$3,404
	6"	.188"	1	2'-6"	3.5"	5' x 8'	168	253	ESR25D61-***	\$3,466	\$4,173	\$4,285	\$3,866
30'	5"	.125"	1	3'-0"	3"	6' x 10'	78	96	ESR30B51-***	\$2,279	\$2,800	\$2,919	\$2,705
	5"	.125"	2	3'-0"	3"	6' x 10'	78	96	ESR30B51-***	\$2,403	\$2,944	\$3,063	\$2,829
	5"	.156"	1	3'-0"	3"	6' x 10'	86	112	ESR30C51-***	\$2,706	\$3,296	\$3,414	\$3,132
	5"	.156"	2	3'-0"	3"	6' x 10'	86	112	ESR30C52-***	\$2,833	\$3,443	\$3,562	\$3,259
	5"	.188"	1	3'-0"	3"	6' x 10'	94	131	ESR30D51-***	\$2,995	\$3,631	\$3,750	\$3,421
	5"	.188"	2	3'-0"	3"	6' x 10'	94	131	ESR30D52-***	\$3,116	\$3,771	\$3,890	\$3,542
	6"	.156"	1	3'-0"	3.5"	6' x 10'	108	174	ESR30C61-***	\$3,295	\$4,012	\$4,152	\$3,793
	6"	.156"	2	3'-0"	3.5"	6' x 10'	108	174	ESR30C62-***	\$3,451	\$4,193	\$4,333	\$3,949
	6"	.188"	1	3'-0"	3.5"	6' x 10'	122	197	ESR30D61-***	\$3,639	\$4,411	\$4,551	\$4,137
	6"	.188"	2	3'-0"	3.5"	6' x 10'	122	197	ESR30D62-***	\$3,709	\$4,492	\$4,632	\$4,207
35'	5"	.156"	1	3'-6"	3"	6' x 10'	73	87	ESR35C51-***	\$2,995	\$3,657	\$3,795	\$3,491
	5"	.156"	2	3'-6"	3"	6' x 10'	73	87	ESR35C52-***	\$3,042	\$3,711	\$3,850	\$3,538
	5"	.188"	1	3'-6"	3"	6' x 10'	79	95	ESR35D51-***	\$3,112	\$3,793	\$3,931	\$3,608
	5"	.188"	2	3'-6"	3"	6' x 10'	79	95	ESR35D52-***	\$3,140	\$3,825	\$3,964	\$3,636
	6"	.156"	1	3'-6"	3.5"	6' x 10'	87	116	ESR35C61-***	\$3,509	\$4,292	\$4,455	\$4,090
	6"	.156"	2	3'-6"	3.5"	6' x 10'	87	116	ESR35C62-***	\$3,639	\$4,442	\$4,606	\$4,220
	6"	.188"	1	3'-6"	3.5"	6' x 10'	97	145	ESR35D61-***	\$4,268	\$5,172	\$5,335	\$4,849
	6"	.188"	2	3'-6"	3.5"	6' x 10'	97	145	ESR35D62-***	\$4,547	\$5,496	\$5,659	\$5,128
	7"	.156"	1	3'-6"	3.5"	6' x 10'	110	165	ESR35C71-***	\$3,971	\$4,862	\$5,051	\$4,637
	7"	.156"	2	3'-6"	3.5"	6' x 10'	110	165	ESR35C72-***	\$4,202	\$5,130	\$5,319	\$4,868
	7"	.188"	1	3'-6"	3.5"	6' x 10'	127	187	ESR35D71-***	\$4,508	\$5,485	\$5,674	\$5,174
	7"	.188"	2	3'-6"	3.5"	6' x 10'	127	187	ESR35D72-***	\$4,681	\$5,686	\$5,874	\$5,347
40'	7"	.156"	1	4'-0"	3.5"	8' x 12'	87	122	ESR40C71-***	\$4,202	\$5,167	\$5,382	\$4,963
	7"	.156"	2	4'-0"	3.5"	8' x 12'	87	122	ESR40C72-***	\$4,726	\$5,775	\$5,990	\$5,487
	8"	.156"	1	4'-0"	4"	8' x 12'	107	157	ESR40C81-***	\$5,058	\$6,202	\$6,452	\$5,916
	8"	.156"	2	4'-0"	3.5"	8' x 12'	107	157	ESR40C82-***	\$5,075	\$6,221	\$6,471	\$5,933
	8"	.188"	1	4'-0"	4"	8' x 12'	123	177	ESR40D81-***	\$5,579	\$6,806	\$7,056	\$6,437
	8"	.188"	2	4'-0"	3.5"	8' x 12'	122	177	ESR40D82-***	\$6,041	\$7,342	\$7,592	\$6,899
45'	8"	.188"	2	4'-6"	3.5"	8' x 12'	102	144	ESR45D82-***	\$6,751	\$8,207	\$8,489	\$7,716
50'	8"	.188"	3	5'-0"	3.5"	10' x 15'	83	117	ESR50D83-***	\$7,279	\$8,861	\$9,174	\$8,351
	10"	.188"	3	5'-0"	4"	10' x 15'	118	164	ESR50D13-***	\$9,103	\$11,077	\$11,470	\$10,417
55'	10"	.188"	3	5'-6"	4"	10' x 15'	102	139	ESR55D13-***	\$9,905	\$12,059	\$12,491	\$11,350
60'	10"	.188"	3	6'-0"	4"	12' x 18'	86	118	ESR60D13-***	\$10,357	\$12,635	\$13,106	\$11,934
	10"	.250"	3	6'-0"	4"	12' x 18'	104	143	ESR60F13-***	\$13,083	\$15,797	\$16,269	\$14,660
	12"	.250"	3	6'-0"	4"	12' x 18'	137	187	ESR60F23-***	\$16,638	\$20,043	\$20,619	\$18,420
65'	12"	.250"	3	6'-6"	4"	12' x 18'	122	165	ESR65F23-***	\$17,842	\$21,502	\$22,125	\$19,773
70'	12"	.250"	3	7'-0"	4"	12' x 18'	109	145	ESR70F23-***	\$18,610	\$22,455	\$23,126	\$20,689
75'	12"	.375"	3	7'-6"	4"	12' x 18'	126	161	ESR75H23-***	\$23,108	\$27,734	\$28,454	\$25,336
80'	12"	.375"	3	8'-0"	4"	15' x 25'	107	144	ESR80H23-***	\$23,788	\$28,585	\$29,352	\$26,164

*** - Finish Options
SAT = Satin
ACL = Anodized - Clear

ADB = Anodized - Dark Bronze
ABL = Anodized - Black
BZT = Powder Coat - Bronze Tone

BLK = Powder Coat - Black
WHT = Powder Coat - White
CLR = Powder Coat - Clear

Quantity Discounts 5+ = 5% 8+ = 10% 15+12%
*Flagpoles From All Flagpole Series May Be Combined To Achieve Quantity Discounts.



Xtreme Series - XESR

Xtreme External Single Revolving - Rope Halyard

The Xtreme Series XESR from Concord American Flagpole provides the unmatched strength of our Xtreme Series External Single Revolving design in heights of 25' to 70'.



STANDARD FLAGPOLE ACCESSORIES - 6" TO 12" BUTT DIAMETERS

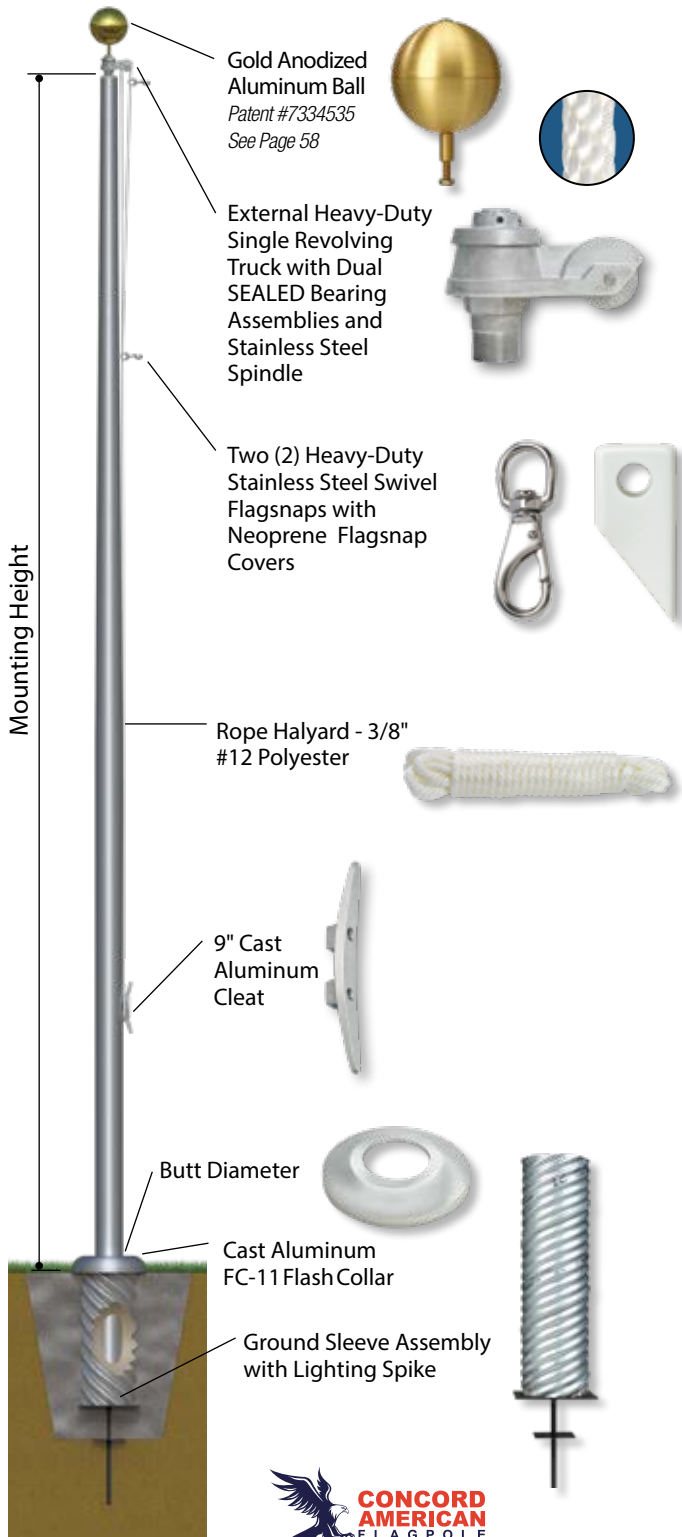

XESR – Xtreme External Single Revolving

The Xtreme Series from Concord American Flagpole provides flagpole owners with the Increased Wind Speed Ratings necessary in coastal, high wind, oversized and multiple flag applications. Years of Engineering, R & D and Manufacturing experience have merged to create the strongest, most efficient increased wind speed flagpoles, combining superior strength with the highest quality Heavy-Duty Component Parts in the industry...External Single Revolving Trucks with Dual SEALED Bearing Assemblies and Stainless Steel Spindle, 3/8" Polyester Halyard, Stainless Steel Swivel Flagnaps and Cast Aluminum Collars.

Standard Specifications

- Patented, Heavy-Duty Gold Anodized Aluminum Ball
- Heavy-Duty Cast Aluminum Revolving Truck with Dual SEALED Bearing Assemblies, Aluminum Pulley and Stainless Steel Spindle
- Complete External Halyard Assembly
 - Rope Halyard - Heavy-Duty 3/8" #12 Polyester
 - Two (2) Heavy-Duty Stainless Swivel Flagnaps
 - Two (2) Neoprene Flagnap Covers
- 9" Cast Aluminum Cleat
- Heavy-Duty Cast Aluminum FC-11 Flash Collar
- Galvanized 16-Gauge Corrugated Steel Ground Sleeve with Steel Grounding Spike

Standard Upgrades – 10" and 12" Butt Diameters

- Heavy-Duty 5/8" Ball Stem
- Two (2) Heavy-Duty 4-1/4" Stainless Steel Flagnaps with Covers



Xtreme Series - XESR Xtreme External Single Revolving - Rope Halyard

MTG HGT.	BUTT DIA.	WALL THICKNESS	POLE SECTIONS	SET DEPTH	TOP DIAM.	STD FLAG SIZE	MAX WIND SPEED WITH NYLON	MAX WIND SPEED NO FLAG	CATALOG NUMBER ***SPECIFY FINISH	DARK BRONZE BRONZE TONE, BLACK, OR BLACK WHITE, OR CLEAR POWDERCOAT			
										Satin	CLEAR ANODIZED	OR BLACK ANODIZED	WHITE, OR CLEAR POWDERCOAT
25'	6"	.250"	1	2'-6"	3.5"	5' x 8'	197	287	XESR25F61-***	\$3,956	\$4,741	\$4,854	\$4,356
30'	6"	.250"	1	3'-0"	3.5"	6' x 10'	150	229	XESR30F61-***	\$4,685	\$5,624	\$5,764	\$5,183
	6"	.250"	2	3'-0"	3.5"	6' x 10'	150	229	XESR30F62-***	\$5,154	\$6,168	\$6,308	\$5,652
	7"	.188"	1	3'-0"	3.5"	6' x 10'	157	235	XESR30D71-***	\$4,062	\$4,931	\$5,093	\$4,633
35'	7"	.250"	1	3'-6"	3.5"	6' x 10'	153	219	XESR35F71-***	\$4,855	\$5,888	\$6,076	\$5,521
	8"	.250"	2	3'-6"	3.5"	6' x 10'	181	249	XESR35F82-***	\$5,939	\$7,182	\$7,401	\$6,689
40'	8"	.250"	1	4'-0"	4"	8' x 12'	146	207	XESR40F81-***	\$7,000	\$8,454	\$8,704	\$7,858
	8"	.250"	2	4'-0"	3.5"	8' x 12'	146	207	XESR40F82-***	\$7,350	\$8,860	\$9,110	\$8,208
45'	10"	.250"	2	4'-6"	4"	8' x 12'	168	226	XESR45F12-***	\$9,451	\$11,429	\$11,782	\$10,634
50'	10"	.250"	3	5'-0"	4"	10' x 15'	140	191	XESR50F13-***	\$10,187	\$12,334	\$12,727	\$11,501
	12"	.250"	3	5'-0"	4"	10' x 15'	179	242	XESR50F23-***	\$13,917	\$16,763	\$17,243	\$15,402
60'	12"	.375"	3	6'-0"	4"	12' x 18'	171	228	XESR60H23-***	\$19,824	\$23,739	\$24,315	\$21,606
70'	12"	.375"	3	7'-0"	4"	12' x 18'	139	181	XESR70H23-***	\$22,170	\$26,584	\$27,256	\$24,249

*** - Finish Options
 SAT = Satin
 ACL = Anodized - Clear
 ADB = Anodized - Dark Bronze
 ABL = Anodized - Black
 BZT = Powder Coat - Bronze Tone
 BLK = Powder Coat - Black
 WHT = Powder Coat - White
 CLR = Powder Coat - Clear

Quantity Discounts
 5+ = 5% 8+ = 10% 15+ = 12%
 *Flagpoles From All Flagpole Series May Be Combined To Achieve Quantity Discounts.

XTREME SERIES - XESR OPTIONS

Double Revolving System with Heavy-Duty Dual SEALED Bearing Assemblies (Double Truck, Extra Cleat and Complete Double Halyard Assembly) – Specify XEDR (Xtreme External Double Revolving). See Page 63 Add \$140



Cast Aluminum, SEALED Bearings, Gold Powder Coated Ball Truck Replaces Standard Truck and Ball Combination - See Page 65.



8" Diameter Ball/Truck Add \$164
 10" Diameter Ball/Truck Add \$220
 12" Diameter Ball/Truck Add \$395

Cleat Cover Box (Specify Cylinder Lock or Padlock). See Page 77 Add \$150



Cleat Cover Box with 5' Halyard Cover (Specify Cylinder Lock or Padlock) - See Page 77. 6" Flagpole Butt Diameters... Add \$304 7"-12" Flagpole Butt Diameters... Add \$364

Flagpole Lighting Options are available for all Xtreme Series XESR Flagpoles – See Pages 84-91.

Shoe Base Designs for Surface Mount Installations are available with all Xtreme Series – XESR Flagpoles. See Page 14.
 6"-8" Butt Diameters Add \$304
 10" Butt Diameters Add \$608
 12" Butt Diameters Add \$1,209

Flagpole Lighting Options are available for all Xtreme Series XESR Flagpoles – See Pages 84-91.

Our INDUSTRY-FIRST Lifetime Flagpole Shaft Warranty assures that a Concord American Flagpole Xtreme Series Flagpole will withstand the worst Mother Nature can throw at it. . . Guaranteed!



Monarch Series - ICC

Internal Cam Cleat - Rope Halyard

The Monarch Series from Concord American Flagpole offers commercial-grade flagpoles with the security of an Internal Rope Halyard and Cam Cleat system. Ranging in heights from 20' to 40', the concealed halyard and lockable flush mount hinged door delivers project owners the peace of mind provided with 24-7 security.

STANDARD FLAGPOLE ACCESSORIES - 5" TO 8" BUTT DIAMETERS

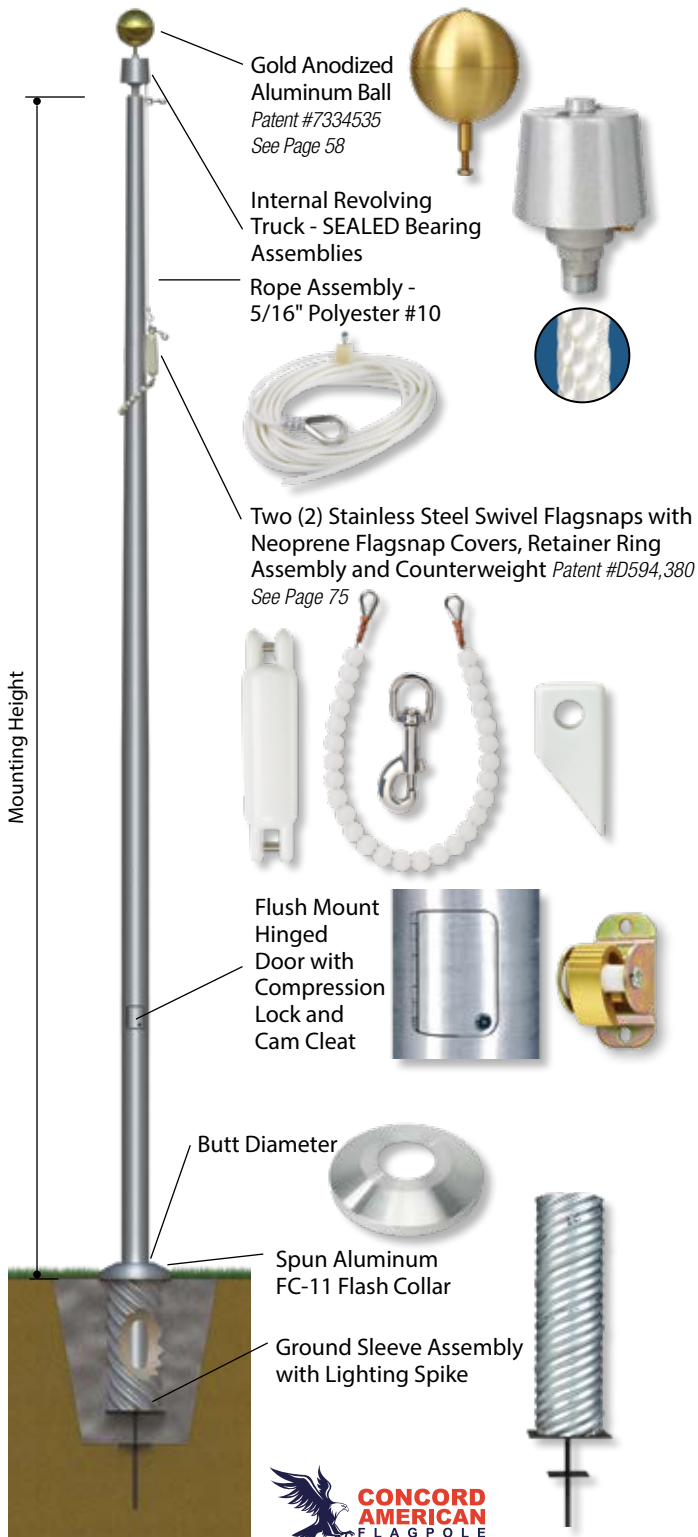

Standard Specifications

- Patented, Heavy-Duty Gold Anodized Aluminum Ball
- Cast Aluminum Revolving Truck with SEALED Stainless Steel Bearing Assemblies, Aluminum Spindle, Cast Brass Exit Bushing and Removable Hood
- Complete Internal Halyard Assembly
 - Rope Halyard - 5/16" #10 Polyester
 - Two (2) Stainless Steel Swivel Flagnaps
 - Two (2) Neoprene Flagnap Covers
- Cam Cleat
- Flush Mount Access Door with Lock and Keys
- Spun Aluminum FC-11 Flash Collar
- Galvanized 16-Gauge Corrugated Steel Ground Sleeve with Steel Grounding Spike

Flush Mount Hinged Door Design

Monarch Flagpoles unite the simplicity of efficient engineering with the aesthetics of a precision cut, rectangular flush mount door design, providing an internal halyard Cam Cleat system that is ideal for low to moderate wind speed areas.



Monarch Series - ICC Internal Cam Cleat - Rope Halyard

MTG HGT.	BUTT DIA.	WALL THICKNESS	POLE SECTIONS	SET DEPTH	TOP DIAM.	STD FLAG SIZE	MAX WIND SPEED WITH NYLON	MAX WIND FLAG SPEED NO FLAG	CATALOG NUMBER ***SPECIFY FINISH	Satin	CLEAR ANODIZED	DARK BRONZE OR BLACK ANODIZED		BRONZE TONE, BLACK, WHITE, OR CLEAR POWDER COAT	
20'	5"	.125"	1	2'0"	3"	4' x 6'	117	204	ICC20B51-***	\$2,591	\$3,110	\$3,189	\$2,875		
	5"	.188"	1	2'0"	3"	4' x 6'	151	272	ICC20D51-***	\$2,948	\$3,524	\$3,603	\$3,232		
25'	5"	.125"	1	2'6"	3"	5' x 8'	84	110	ICC25B51-***	\$2,769	\$3,338	\$3,433	\$3,111		
	5"	.156"	1	2'6"	3"	5' x 8'	93	129	ICC25C51-***	\$3,103	\$3,725	\$3,821	\$3,445		
	6"	.156"	1	2'6"	3.5"	5' x 8'	126	216	ICC25C61-***	\$3,615	\$4,346	\$4,458	\$4,015		
	6"	.188"	1	2'6"	3.5"	5' x 8'	144	240	ICC25D61-***	\$3,815	\$4,578	\$4,690	\$4,215		
30'	6"	.156"	1	3'0"	3.5"	6' x 10'	91	138	ICC30C61-***	\$3,817	\$4,617	\$4,757	\$4,315		
	6"	.156"	2	3'0"	3.5"	6' x 10'	91	138	ICC30C62-***	\$4,039	\$4,875	\$5,015	\$4,537		
	6"	.188"	1	3'0"	3.5"	6' x 10'	102	170	ICC30D61-***	\$4,200	\$5,062	\$5,202	\$4,698		
	6"	.188"	2	3'0"	3.5"	6' x 10'	102	170	ICC30D62-***	\$4,451	\$5,353	\$5,493	\$4,949		
35'	6"	.156"	1	3'6"	3.5"	6' x 10'	74	93	ICC35C61-***	\$4,062	\$4,933	\$5,096	\$4,643		
	6"	.156"	2	3'6"	3.5"	6' x 10'	74	93	ICC35C62-***	\$4,467	\$5,403	\$5,566	\$5,048		
	7"	.156"	1	3'6"	3.5"	6' x 10'	95	142	ICC35C71-***	\$4,484	\$5,457	\$5,646	\$5,150		
	7"	.156"	2	3'6"	3.5"	6' x 10'	95	142	ICC35C72-***	\$4,932	\$5,977	\$6,166	\$5,598		
	7"	.188"	1	3'6"	3.5"	6' x 10'	107	167	ICC35D71-***	\$5,063	\$6,129	\$6,318	\$5,729		
	7"	.188"	2	3'6"	3.5"	6' x 10'	107	167	ICC35D72-***	\$5,571	\$6,718	\$6,907	\$6,237		
40'	7"	.156"	1	4'0"	3.5"	8' x 12'	75	99	ICC40C71-***	\$5,259	\$6,393	\$6,608	\$6,020		
	7"	.156"	2	4'0"	3.5"	8' x 12'	75	99	ICC40C72-***	\$5,785	\$7,003	\$7,218	\$6,546		
	8"	.156"	1	4'0"	4"	8' x 12'	94	140	ICC40C81-***	\$5,604	\$6,835	\$7,085	\$6,462		
	8"	.156"	2	4'0"	3.5"	8' x 12'	94	140	ICC40C82-***	\$5,885	\$7,161	\$7,411	\$6,743		
	8"	.188"	1	4'0"	4"	8' x 12'	107	161	ICC40D81-***	\$6,165	\$7,486	\$7,736	\$7,023		
	8"	.188"	2	4'0"	3.5"	8' x 12'	107	161	ICC40D82-***	\$6,475	\$7,845	\$8,095	\$7,333		

*** - Finish Options

- SAT = Satin
- ACL = Anodized - Clear
- ADB = Anodized - Dark Bronze
- ABL = Anodized - Black
- BZT = Powder Coat - Bronze Tone
- BLK = Powder Coat - Black
- WHT = Powder Coat - White
- CLR = Powder Coat - Clear

Quantity Discounts

5+ = 5% 8+ = 10% 15+ = 12%
 *Flagpoles From All Flagpole Series May Be Combined To Achieve Quantity Discounts.

MONARCH SERIES - ICC OPTIONS

Cast Aluminum, SEALED Bearings, Gold Powder Coated Ball Truck
 Replaces Standard Truck and Ball Combination - See Page 68.

8" Diameter Ball/Truck Add \$164
 10" Diameter Ball/Truck..... Add \$220



Cast Aluminum FC-11 In Lieu of Spun Collar - See Page 81.
 5"-7" Butt Diameters Add \$67
 8" Butt Diameters Add \$201



Shoe Base Designs for Surface Mount Installations are available with all Monarch Series - ICC Flagpoles. See Page 14.

5" Butt Diameters Add \$246
 6"-8" Butt Diameters Add \$304

Flagpole Lighting Options are available for all Monarch Series ICC Flagpoles - See Pages 84-91.

Sentry Series - ISC

Internal Cam Cleave with Reinforced Raised Door Frame - Rope Halyard

The Sentry Series from Concord American Flagpole offers Cam Cleave system flagpoles in heights from 20' to 40'. The raised reinforced door frame design provides the security of an Internal Rope Halyard and Cam Cleave system with the reinforced strength necessary for moderate wind speed areas.



STANDARD FLAGPOLE ACCESSORIES - 5" TO 7" BUTT DIAMETERS

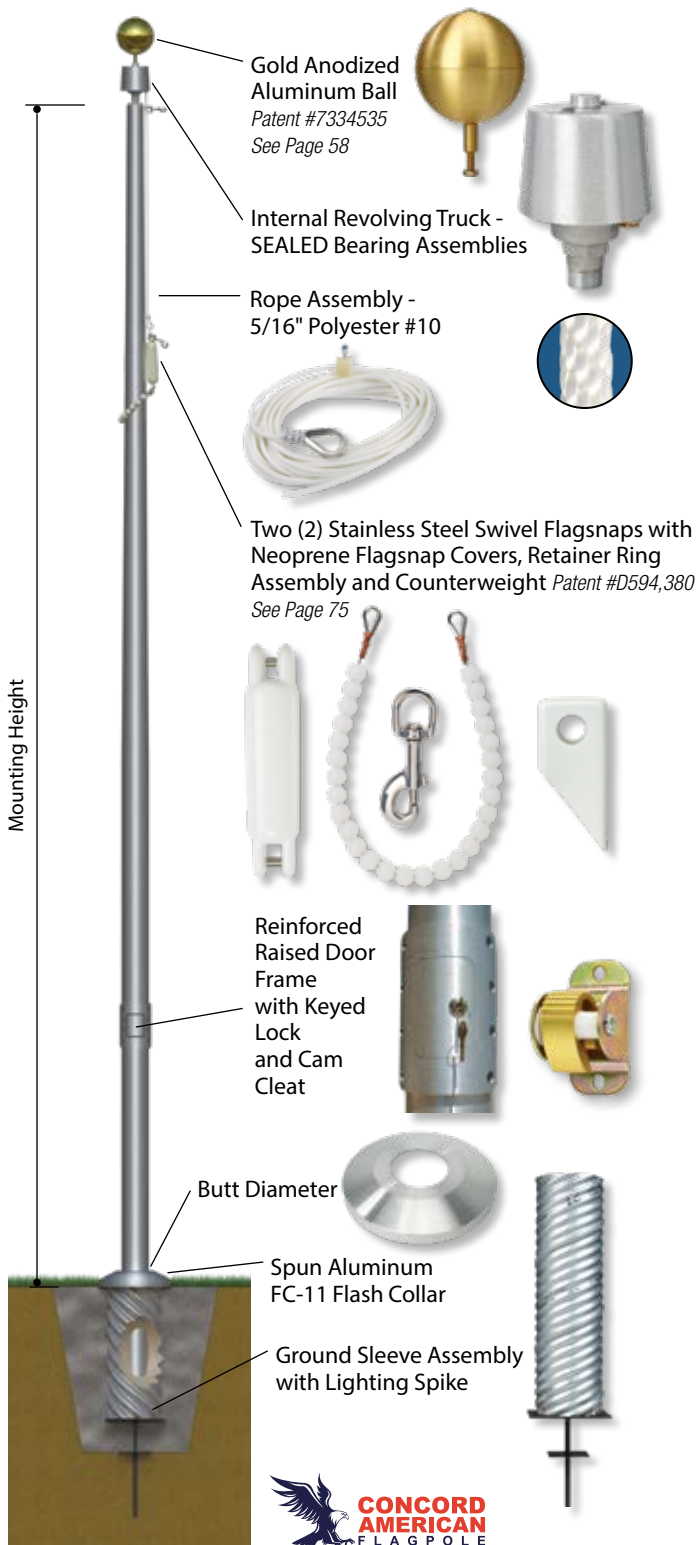

Standard Specifications

- Patented, Heavy-Duty Gold Anodized Aluminum Ball
- Cast Aluminum Revolving Truck with SEALED Stainless Steel Bearing Assemblies, Aluminum Spindle, Cast Brass Exit Bushing and Removable Hood
- Complete Internal Halyard Assembly
 - Rope Halyard - 5/16" #10 Polyester
 - Two (2) Stainless Steel Flagsnaps
 - Two (2) Neoprene Flagsnap Covers
- Cam Cleave
- Reinforced Raised Door Frame
- Flush Mount Access Door with Lock and Keys
- Spun Aluminum FC-11 Flash Collar
- Galvanized 16-Gauge Corrugated Steel Ground Sleeve with Steel Grounding Spike

Reinforced Raised Door Frame

Sentry Flagpoles are designed with a patented raised reinforced door frame consisting of a matched set of inner and outer castings. The frame castings are attached to the flagpole shaft using a series of eight (8) tamper-proof 5/16-18NC stainless steel bolts. The aluminum door is secured with two (2) tamper-proof 1/4-20NC screws.



Patent #7717055



Sentry Series - ISC Internal Cam Cleat with Reinforced Raised Door Frame - Rope Halyard

MTG HGT.	BUTT DIA.	WALL THICKNESS	POLE SECTIONS	SET DEPTH	TOP DIAM.	STD FLAG SIZE	MAX WIND SPEED WITH NYLON	MAX WIND SPEED NO FLAG	CATALOG NUMBER ***SPECIFY FINISH	Satin	CLEAR ANODIZED	DARK BRONZE OR BLACK ANODIZED	BRONZE TONE, BLACK, WHITE, OR CLEAR POWDER COAT
20'	5"	.125"	1	2'0"	3"	4' x 6'	136	229	ISC20B51-***	\$2,412	\$2,903	\$2,982	\$2,696
	5"	.156"	1	2'0"	3"	4' x 6'	160	262	ISC20C51-***	\$2,638	\$3,165	\$3,244	\$2,922
	5"	.188"	1	2'0"	3"	4' x 6'	182	287	ISC20D51-***	\$2,921	\$3,493	\$3,572	\$3,205
	6"	.156"	1	2'0"	3.5"	4' x 6'	208	301	ISC20C61-***	\$3,052	\$3,667	\$3,760	\$3,384
	6"	.188"	1	2'0"	3.5"	4' x 6'	229	328	ISC20D61-***	\$3,699	\$4,417	\$4,511	\$4,031
25'	5"	.125"	1	2'6"	3"	5' x 8'	98	136	ISC25B51-***	\$2,613	\$3,157	\$3,252	\$2,955
	5"	.156"	1	2'6"	3"	5' x 8'	111	178	ISC25C51-***	\$2,978	\$3,580	\$3,676	\$3,320
	5"	.188"	1	2'6"	3"	5' x 8'	124	209	ISC25D51-***	\$3,537	\$4,229	\$4,324	\$3,879
	6"	.156"	1	2'6"	3.5"	5' x 8'	149	230	ISC25C61-***	\$3,682	\$4,423	\$4,536	\$4,082
	6"	.188"	1	2'6"	3.5"	5' x 8'	168	253	ISC25D61-***	\$3,795	\$4,555	\$4,667	\$4,195
30'	5"	.188"	1	3'0"	3"	6' x 10'	94	131	ISC30D51-***	\$3,561	\$4,287	\$4,406	\$3,987
	5"	.188"	2	3'0"	3"	6' x 10'	94	131	ISC30D52-***	\$3,722	\$4,474	\$4,593	\$4,148
	6"	.156"	1	3'0"	3.5"	6' x 10'	108	174	ISC30C61-***	\$3,876	\$4,686	\$4,826	\$4,374
	6"	.156"	2	3'0"	3.5"	6' x 10'	108	174	ISC30C62-***	\$4,046	\$4,883	\$5,023	\$4,544
	6"	.188"	1	3'0"	3.5"	6' x 10'	122	197	ISC30D61-***	\$4,121	\$4,970	\$5,110	\$4,619
	6"	.188"	2	3'0"	3.5"	6' x 10'	122	197	ISC30D62-***	\$4,208	\$5,071	\$5,211	\$4,706
35'	6"	.156"	1	3'6"	3.5"	6' x 10'	87	116	ISC35C61-***	\$4,070	\$4,942	\$5,106	\$4,651
	6"	.156"	2	3'6"	3.5"	6' x 10'	87	116	ISC35C62-***	\$4,216	\$5,112	\$5,275	\$4,797
	6"	.188"	1	3'6"	3.5"	6' x 10'	97	145	ISC35D61-***	\$4,847	\$5,844	\$6,007	\$5,428
	6"	.188"	2	3'6"	3.5"	6' x 10'	97	145	ISC35D62-***	\$5,187	\$6,238	\$6,401	\$5,768
	7"	.156"	1	3'6"	3.5"	6' x 10'	110	165	ISC35C71-***	\$4,588	\$5,578	\$5,767	\$5,254
	7"	.156"	2	3'6"	3.5"	6' x 10'	110	165	ISC35C72-***	\$4,822	\$5,849	\$6,038	\$5,488
	7"	.188"	1	3'6"	3.5"	6' x 10'	127	187	ISC35D71-***	\$5,114	\$6,188	\$6,377	\$5,780
	7"	.188"	2	3'6"	3.5"	6' x 10'	127	187	ISC35D72-***	\$5,300	\$6,404	\$6,592	\$5,966
40'	7"	.156"	1	4'0"	3.5"	8' x 12'	87	122	ISC40C71-***	\$5,361	\$6,511	\$6,727	\$6,122
	7"	.156"	2	4'0"	3.5"	8' x 12'	87	122	ISC40C72-***	\$5,526	\$6,703	\$6,918	\$6,287

*** - Finish Options

- SAT = Satin
- ACL = Anodized - Clear
- ADB = Anodized - Dark Bronze
- ABL = Anodized - Black
- BZT = Powder Coat - Bronze Tone
- BLK = Powder Coat - Black
- WHT = Powder Coat - White
- CLR = Powder Coat - Clear

Quantity Discounts

5+ = 5% 8+ = 10% 15+ = 12%
 *Flagpoles From All Flagpole Series May Be Combined To Achieve Quantity Discounts.

SENTRY SERIES - ISC OPTIONS

Cast Aluminum, SEALED Bearings, Gold Powder Coated Ball Truck
 Replaces Standard Truck and Ball Combination - See Page 68.

8" Diameter Ball/Truck Add \$164
 10" Diameter Ball/Truck..... Add \$220



Cast Aluminum FC-11 In Lieu of Spun Collar - See Page 81.
 5"-7" Butt Diameters Add \$67



Flagpole Lighting Options are available for all Sentry Series ISC Flagpoles - See Pages 84-91.

Shoe Base Designs for Surface Mount Installations are available with all Sentry Series - ISC Flagpoles. See Page 14.

5" Butt Diameters Add \$246
 6"-7" Butt Diameters Add \$304

Flagpole Lighting Options are available for all Sentry Series ISC Flagpoles - See Pages 84-91.

Sentry II Series - IRC

Internal Reinforced with Cam Cleat - Rope Halyard

The Sentry II Series from Concord American Flagpole is the perfect choice when your project calls for a commercial grade flagpole utilizing an Internal Rope Halyard and Cam Cleat system. Offered in heights of 20' to 40', the reinforced welded door frame delivers exceptional strength, combining security with the superior aesthetics achieved from the lockable flush mount door.

STANDARD FLAGPOLE ACCESSORIES - 6" TO 8" BUTT DIAMETERS



Standard Specifications

- Patented, Heavy-Duty Gold Anodized Aluminum Ball
- Cast Aluminum Revolving Truck with SEALED Stainless Steel Bearing Assemblies, Aluminum Spindle, Cast Brass Exit Bushing and Removable Hood
- Complete Internal Halyard Assembly
 - Rope Halyard - 5/16" #10 Polyester
 - Two (2) Stainless Steel Swivel Flagnaps
 - Two (2) Neoprene Flagnap Covers
- Cam Cleat
- Reinforced Welded Door Frame
- Flush Mount Access Door with Lock and Keys
- Spun Aluminum FC-11 Flash Collar
- Galvanized 16-Gauge Corrugated Steel Ground Sleeve with Steel Grounding Spike

Reinforced Welded Door Frame

Sentry II Flagpoles are engineered with an inset reinforced aluminum door frame welded into the precision cut door opening, providing additional strength and higher max wind speeds from each butt diameter/wall thickness combination. The efficiency of this design produces maximum strength-to-size ratios while providing a smooth, flush fitting door, making our Sentry II IRC flagpoles the ideal choice in many applications.



Sentry II Series - IRC Internal Reinforced with Cam Cleat - Rope Halyard

MTG HGT.	BUTT DIA.	WALL THICKNESS	POLE SECTIONS	SET DEPTH	TOP DIAM.	STD FLAG SIZE	MAX WIND SPEED WITH NYLON	MAX WIND SPEED NO FLAG	CATALOG NUMBER ***SPECIFY FINISH	Satin	CLEAR ANODIZED	DARK BRONZE	BRONZE TONE, BLACK,
												OR BLACK ANODIZED	WHITE, OR CLEAR POWDERCOAT
20'	6"	.156"	1	2'0"	3.5"	4' x 6'	208	301	IRC20C61-***	\$3,334	\$3,994	\$4,087	\$3,666
	6"	.188"	1	2'0"	3.5"	4' x 6'	229	328	IRC20D61-***	\$4,043	\$4,816	\$4,910	\$4,375
25'	6"	.156"	1	2'6"	3.5"	5' x 8'	149	230	IRC25C61-***	\$3,869	\$4,640	\$4,753	\$4,269
	6"	.188"	1	2'6"	3.5"	5' x 8'	168	253	IRC25D61-***	\$4,252	\$5,085	\$5,197	\$4,652
30'	6"	.156"	1	3'0"	3.5"	6' x 10'	108	174	IRC30C61-***	\$4,167	\$5,023	\$5,163	\$4,665
	6"	.156"	2	3'0"	3.5"	6' x 10'	108	174	IRC30C62-***	\$4,376	\$5,266	\$5,406	\$4,874
	6"	.188"	1	3'0"	3.5"	6' x 10'	122	197	IRC30D61-***	\$4,500	\$5,410	\$5,550	\$4,998
	6"	.188"	2	3'0"	3.5"	6' x 10'	122	197	IRC30D62-***	\$4,542	\$5,458	\$5,598	\$5,040
	7"	.188"	1	3'0"	3.5"	6' x 10'	157	235	IRC30D71-***	\$4,668	\$5,634	\$5,796	\$5,239
35'	6"	.156"	1	3'6"	3.5"	6' x 10'	87	116	IRC35C61-***	\$4,701	\$5,674	\$5,838	\$5,282
	6"	.156"	2	3'6"	3.5"	6' x 10'	87	116	IRC35C62-***	\$5,085	\$6,120	\$6,283	\$5,666
	6"	.188"	1	3'6"	3.5"	6' x 10'	97	145	IRC35D61-***	\$5,326	\$6,399	\$6,563	\$5,907
	6"	.188"	2	3'6"	3.5"	6' x 10'	97	145	IRC35D62-***	\$5,543	\$6,651	\$6,814	\$6,124
	7"	.156"	1	3'6"	3.5"	6' x 10'	110	165	IRC35C71-***	\$5,292	\$6,395	\$6,583	\$5,958
	7"	.156"	2	3'6"	3.5"	6' x 10'	110	165	IRC35C72-***	\$5,403	\$6,523	\$6,712	\$6,069
	7"	.188"	1	3'6"	3.5"	6' x 10'	127	187	IRC35D71-***	\$5,667	\$6,830	\$7,018	\$6,333
	7"	.188"	2	3'6"	3.5"	6' x 10'	127	187	IRC35D72-***	\$5,876	\$7,072	\$7,261	\$6,542
	8"	.188"	1	3'6"	4"	6' x 10'	155	213	IRC35D81-***	\$6,007	\$7,261	\$7,480	\$6,757
40'	7"	.156"	1	4'0"	3.5"	8' x 12'	87	122	IRC40C71-***	\$5,905	\$7,142	\$7,358	\$6,666
	7"	.156"	2	4'0"	3.5"	8' x 12'	87	122	IRC40C72-***	\$6,126	\$7,399	\$7,614	\$6,887
	7"	.188"	1	4'0"	3.5"	8' x 12'	103	147	IRC40D71-***	\$6,250	\$7,542	\$7,758	\$7,011
	8"	.156"	1	4'0"	4"	8' x 12'	107	157	IRC40C81-***	\$6,478	\$7,849	\$8,099	\$7,336
	8"	.156"	2	4'0"	3.5"	8' x 12'	107	157	IRC40C82-***	\$6,626	\$8,020	\$8,271	\$7,484
	8"	.188"	1	4'0"	4"	8' x 12'	123	177	IRC40D81-***	\$6,816	\$8,241	\$8,491	\$7,674
	8"	.188"	2	4'0"	3.5"	8' x 12'	122	177	IRC40D82-***	\$6,959	\$8,407	\$8,657	\$7,817
	8"	.250"	1	4'0"	4"	8' x 12'	146	205	IRC40F81-***	\$7,444	\$8,969	\$9,219	\$8,302
	8"	.250"	2	4'0"	3.5"	8' x 12'	146	205	IRC40F82-***	\$8,032	\$9,651	\$9,902	\$8,890

*** - Finish Options

- SAT = Satin
- ACL = Anodized - Clear
- ADB = Anodized - Dark Bronze
- ABL = Anodized - Black
- BZT = Powder Coat - Bronze Tone
- BLK = Powder Coat - Black
- WHT = Powder Coat - White
- CLR = Powder Coat - Clear

Quantity Discounts

5+ = 5% 8+ = 10% 15+ = 12%
 *Flagpoles From All Flagpole Series May Be Combined To Achieve Quantity Discounts.

SENTRY II SERIES - IRC OPTIONS

Cast Aluminum, SEALED Bearings, Gold Powder Coated Ball Truck
 Replaces Standard Truck and Ball Combination - See Page 68.

8" Diameter Ball/Truck Add \$164
 10" Diameter Ball/Truck..... Add \$220

Cast Aluminum FC-11 In Lieu of Spun Collar - See Page 81.
 6"-7" Butt Diameters Add \$67
 8" Butt Diameters Add \$201





Shoe Base Designs for Surface Mount Installations are available with all Sentry II Series - IRC Flagpoles. See Page 14.
 6"-8" Butt Diameters Add \$304

Flagpole Lighting Options are available for all Sentry II Series IRC Flagpoles - See Pages 84-91.

Titan Series - IWW

Internal With Winch - Wire Halyard

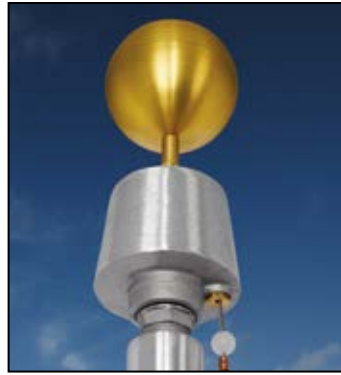
The Titan Series from Concord American Flagpole offers commercial grade flagpoles with the security of an Internal Halyard Winch and Wire Cable system. Ranging in heights from 20' to 80', the concealed halyard and lockable flush mount hinged door delivers project owners the peace of mind provided with 24-7 security.



STANDARD FLAGPOLE ACCESSORIES - 6" TO 8" BUTT DIAMETERS

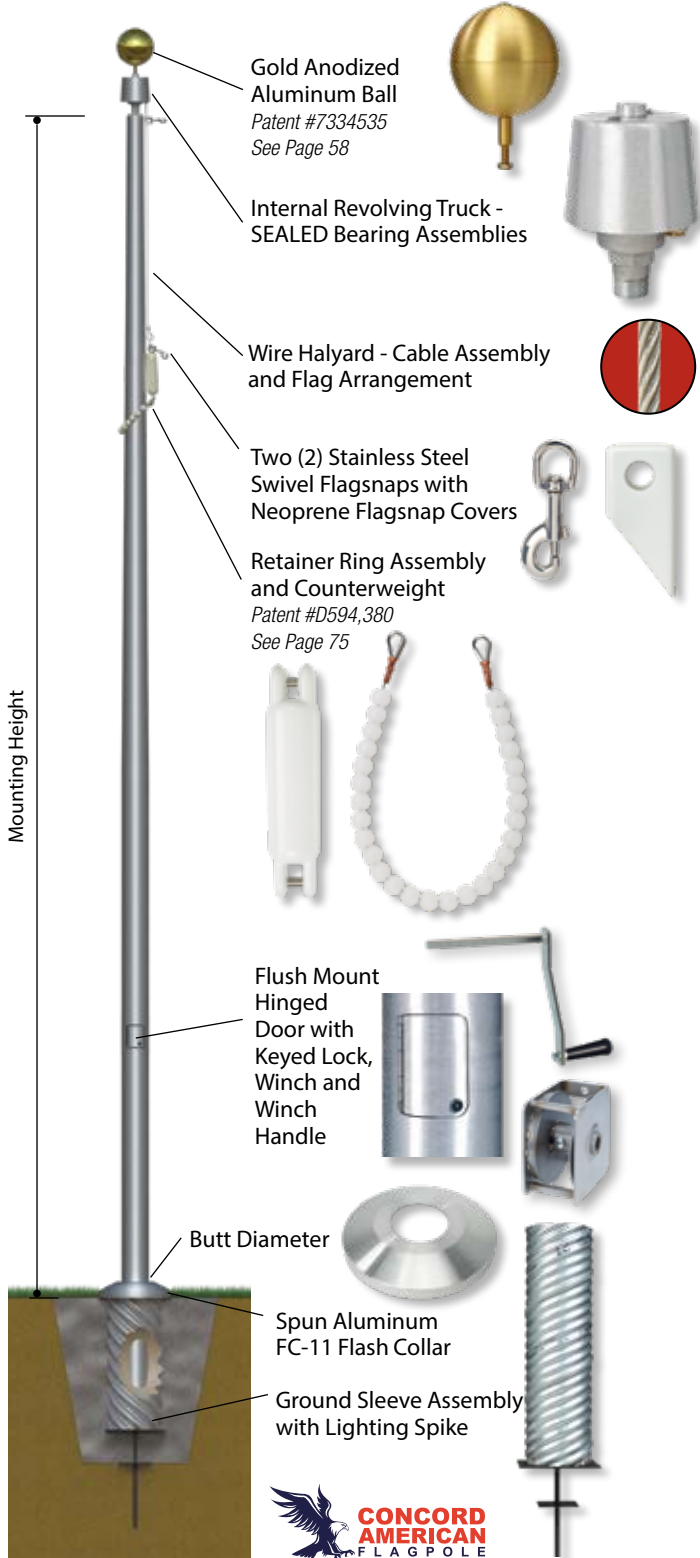

Standard Specifications

- Patented, Heavy-Duty Gold Anodized Aluminum Ball
- Cast Aluminum Revolving Truck with Dual SEALED Stainless Steel Bearing Assemblies, Aluminum Spindle, Cast Brass Exit Bushing and Removable Hood
- Complete Internal Halyard Assembly
 - Wire Halyard Cable Assembly
 - Flag Arrangement (8' x 12' and Larger Flags Include Heavy-Duty Shock Spring Assembly)
 - Two (2) Stainless Steel Swivel Flagnaps
 - Two (2) Neoprene Flagnap Covers
 - Patented, Plastic Coated Counterweight
 - Beaded Retainer Ring Assembly
- Stainless Steel Winch Assembly with Removable Hand Crank
- Flush Mount Access Door with Lock and Keys
- Spun Aluminum FC-11 Flash Collar
- Galvanized 16-Gauge Corrugated Steel Ground Sleeve with Steel Grounding Spike

Standard Upgrades - 10" and 12" Butt Diameters

- Heavy-Duty, Large Cast Aluminum Revolving Truck with Dual SEALED Stainless Steel Bearing Assemblies, Aluminum Spindle, Cast Brass Exit Bushing and Removable Hood
- Two (2) Heavy-Duty Stainless Steel Flagnaps
- Heavy-Duty Cast Aluminum FC-11 Flash Collar
- Heavy-Duty 5/8" Ball Stem

Flush Mount Hinged Door Design

Titan Flagpoles unite the simplicity of efficient engineering with the aesthetics of a precision cut, rectangular flush mount door design, providing an internal halyard Winch system that is ideal for low to moderate wind speed areas.



Titan Series - IWW Internal With Winch - Wire Halyard

MTG HGT.	BUTT DIA.	WALL THICKNESS	POLE SECTIONS	SET DEPTH	TOP DIAM.	STD FLAG SIZE	MAX WIND SPEED WITH NYLON	MAX WIND FLAG SPEED NO FLAG	CATALOG NUMBER ***SPECIFY FINISH	Satin	CLEAR ANODIZED	DARK BRONZE	BRONZE TONE, BLACK,
												OR BLACK ANODIZED	WHITE, OR CLEAR POWDERCOAT
20'	6"	.156"	1	2'0"	3.5"	4' x 6'	152	256	IWW20C61-***	\$3,566	\$4,263	\$4,357	\$3,898
	6"	.188"	1	2'0"	3.5"	4' x 6'	174	280	IWW20D61-***	\$4,015	\$4,784	\$4,877	\$4,347
25'	6"	.156"	1	2'6"	3.5"	5' x 8'	100	162	IWW25C61-***	\$4,439	\$5,302	\$5,414	\$4,839
	6"	.188"	1	2'6"	3.5"	5' x 8'	112	192	IWW25D61-***	\$4,628	\$5,521	\$5,633	\$5,028
30'	6"	.156"	1	3'0"	3.5"	6' x 10'	75	98	IWW30C61-***	\$4,939	\$5,919	\$6,059	\$5,437
	6"	.156"	2	3'0"	3.5"	6' x 10'	75	98	IWW30C62-***	\$4,996	\$5,985	\$6,125	\$5,494
	6"	.188"	1	3'0"	3.5"	6' x 10'	83	114	IWW30D61-***	\$5,384	\$6,435	\$6,575	\$5,882
	6"	.188"	2	3'0"	3.5"	6' x 10'	83	114	IWW30D62-***	\$5,433	\$6,492	\$6,632	\$5,931
	7"	.156"	1	3'0"	3.5"	6' x 10'	105	162	IWW30C71-***	\$5,613	\$6,731	\$6,892	\$6,184
	7"	.156"	2	3'0"	3.5"	6' x 10'	105	162	IWW30C72-***	\$5,732	\$6,869	\$7,030	\$6,303
	7"	.188"	1	3'0"	3.5"	6' x 10'	113	188	IWW30D71-***	\$5,793	\$6,939	\$7,101	\$6,364
	7"	.188"	2	3'0"	3.5"	6' x 10'	113	188	IWW30D72-***	\$6,372	\$7,611	\$7,773	\$6,943
35'	7"	.156"	1	3'6"	3.5"	6' x 10'	80	106	IWW35C71-***	\$5,828	\$7,016	\$7,205	\$6,494
	7"	.156"	2	3'6"	3.5"	6' x 10'	80	106	IWW35C72-***	\$6,318	\$7,585	\$7,773	\$6,984
	7"	.188"	1	3'6"	3.5"	6' x 10'	90	127	IWW35D71-***	\$6,415	\$7,697	\$7,886	\$7,081
	7"	.188"	2	3'6"	3.5"	6' x 10'	90	127	IWW35D72-***	\$6,948	\$8,316	\$8,504	\$7,614
	8"	.188"	1	3'6"	4"	6' x 10'	119	179	IWW35D81-***	\$6,497	\$7,829	\$8,048	\$7,247
	8"	.188"	2	3'6"	3.5"	6' x 10'	119	179	IWW35D82-***	\$7,147	\$8,583	\$8,802	\$7,897
40'	7"	.156"	1	4'0"	3.5"	8' x 12'	65	80	IWW40C71-***	\$6,417	\$7,736	\$7,952	\$7,178
	7"	.156"	2	4'0"	3.5"	8' x 12'	65	80	IWW40C72-***	\$6,953	\$8,358	\$8,573	\$7,714
	8"	.156"	1	4'0"	4"	8' x 12'	81	113	IWW40C81-***	\$7,057	\$8,520	\$8,771	\$7,915
	8"	.156"	2	4'0"	3.5"	8' x 12'	81	113	IWW40C82-***	\$7,153	\$8,632	\$8,882	\$8,011
	8"	.188"	1	4'0"	4"	8' x 12'	91	134	IWW40D81-***	\$7,309	\$8,813	\$9,063	\$8,167
	8"	.188"	2	4'0"	3.5"	8' x 12'	91	134	IWW40D82-***	\$7,845	\$9,435	\$9,685	\$8,703
	10"	.188"	2	4'0"	4"	8' x 12'	141	204	IWW40D12-***	\$8,040	\$9,740	\$10,055	\$9,091
45'	8"	.188"	2	4'6"	3.5"	8' x 12'	76	100	IWW45D82-***	\$8,320	\$10,027	\$10,309	\$9,285
	10"	.188"	2	4'6"	4"	8' x 12'	118	167	IWW45D12-***	\$8,734	\$10,597	\$10,951	\$9,917
50'	10"	.188"	3	5'0"	4"	10' x 15'	94	136	IWW50D13-***	\$10,101	\$12,234	\$12,627	\$11,415
	10"	.250"	3	5'0"	4"	10' x 15'	115	165	IWW50F13-***	\$11,747	\$14,144	\$14,537	\$13,061
60'	10"	.188"	3	6'0"	4"	12' x 18'	68	89	IWW60D13-***	\$11,391	\$13,834	\$14,306	\$12,968
	10"	.250"	3	6'0"	4"	12' x 18'	82	113	IWW60F13-***	\$14,106	\$16,984	\$17,455	\$15,683
	12"	.250"	3	6'0"	4"	12' x 18'	117	166	IWW60F23-***	\$17,530	\$21,078	\$21,654	\$19,312
70'	12"	.250"	3	7'0"	4"	12' x 18'	90	122	IWW70F23-***	\$19,287	\$23,240	\$23,912	\$21,366
80'	12"	.375"	3	8'0"	4"	15' x 25'	89	121	IWW80H23-***	\$24,293	\$29,171	\$29,938	\$26,669

***** - Finish Options**

- SAT = Satin
- ACL = Anodized - Clear
- ADB = Anodized - Dark Bronze
- ABL = Anodized - Black
- BZT = Powder Coat - Bronze Tone
- BLK = Powder Coat - Black
- WHT = Powder Coat - White
- CLR = Powder Coat - Clear

Quantity Discounts

5+ = 5% 8+ = 10% 15+ = 12%
 *Flagpoles From All Flagpole Series May Be Combined To Achieve Quantity Discounts.

TITAN SERIES - IWW OPTIONS

Cast Aluminum, SEALED Bearings, Gold Powder Coated Ball Truck
 Replaces Standard Truck and Ball Combination - See Page 68.



8" Diameter Ball/Truck Add \$164
 10" Diameter Ball/Truck Add \$220
 12" Diameter Ball/Truck Add \$395

Cast Aluminum FC-11 In Lieu of Spun Collar - See Page 81.



6"-7" Butt Diameters Add \$67
 8"-12" Butt Diameters Add \$201

Flagpole Lighting Options are available for all Titan Series IWW Flagpoles - See Pages 84-91.

Shoe Base Designs for Surface Mount Installations are available with all Titan Series - IWW Flagpoles.

See Page 14.
 6"-8" Butt Diameters Add \$304
 10" Butt Diameters Add \$608
 12" Butt Diameters Add \$1,209

Flagpole Lighting Options are available for all Titan Series IWW Flagpoles - See Pages 84-91.



Sovereignty Series - ISW

Internal Winch with Reinforced Raised Door Frame

The Sovereignty Series from Concord American Flagpole offers flagpoles in butt diameters from 5" to 7" and heights from 20' to 40'. The raised reinforced door frame design combines the security of an Internal Halyard Winch and Wire Cable system with the reinforced strength necessary for moderate wind speed areas.

STANDARD FLAGPOLE ACCESSORIES - 5" TO 7" BUTT DIAMETERS

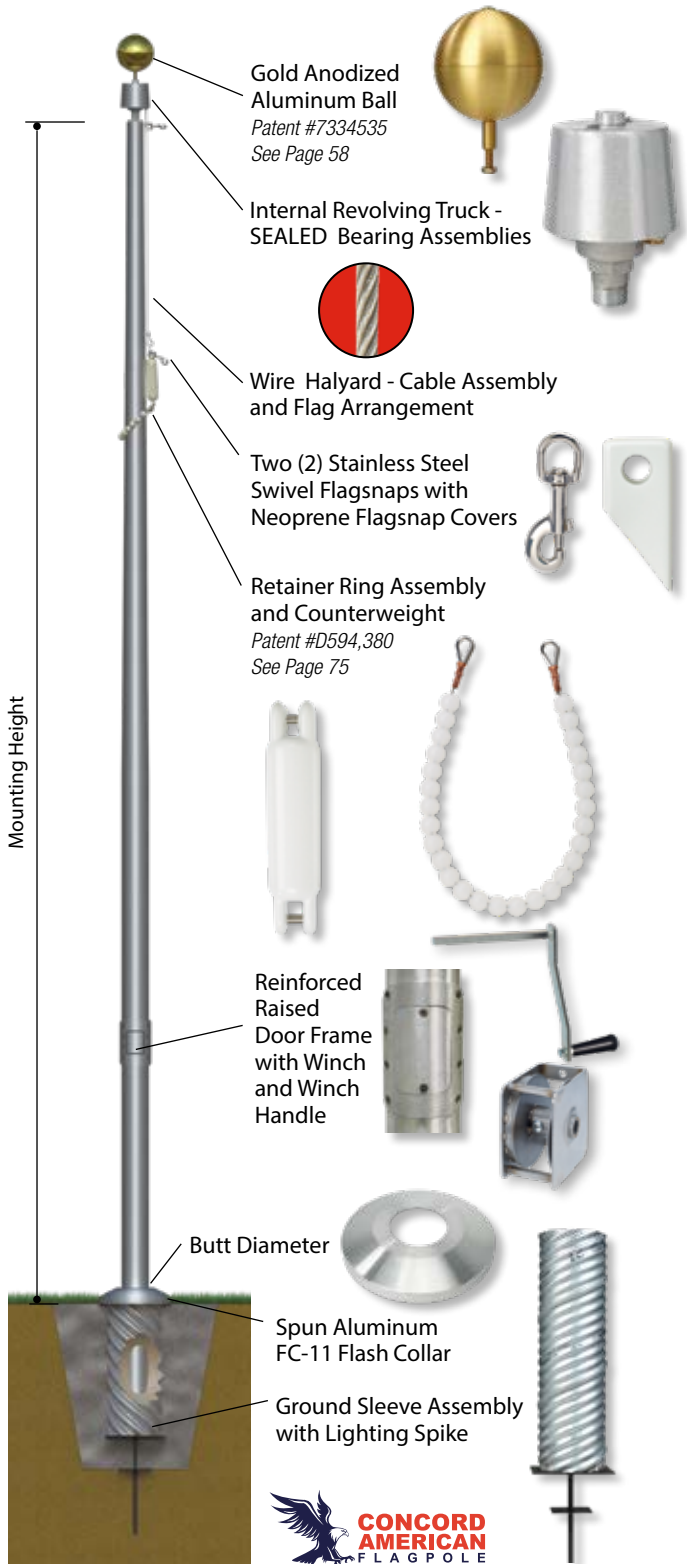

Standard Specifications

- Patented, Heavy-Duty Gold Anodized Aluminum Ball
- Cast Aluminum Revolving Truck with Dual SEALED Stainless Steel Bearing Assemblies, Aluminum Spindle, Cast Brass Exit Bushing and Removable Hood
- Complete Internal Halyard Assembly
 - Wire Halyard Cable Assembly
 - Flag Arrangement (8' x 12' and Larger Flags Include Heavy-Duty Shock Spring Assembly)
 - Two (2) Stainless Steel Swivel Flagnaps
 - Two (2) Neoprene Flagnap Covers
 - Patented, Plastic Coated Counterweight
 - Beaded Retainer Ring Assembly
- Stainless Steel Winch Assembly with Removable Hand Crank
- Reinforced Raised Door Frame
- Flush Mount Access Door with two (2) Tamper Proof Screws
- Spun Aluminum FC-11 Flash Collar
- Galvanized 16-Gauge Corrugated Steel Ground Sleeve with Steel Grounding Spike

Reinforced Raised Door Frame

Sovereignty Flagpoles are designed with a patented raised reinforced door frame consisting of a matched set of inner AND outer castings. The frame castings are attached to the flagpole shaft using a series of eight (8) tamper-proof 5/16-18NC stainless steel bolts. The aluminum door is secured with two (2) tamper-proof 1/4-20NC screws.



Patent #7717055



Sovereignty Series - ISW Internal Winch with Reinforced Raised Door Frame - Wire Halyard

MTG HGT.	BUTT DIA.	WALL THICKNESS	POLE SECTIONS	SET DEPTH	TOP DIAM.	STD FLAG SIZE	MAX WIND SPEED WITH NYLON	MAX WIND FLAG SPEED NO FLAG	CATALOG NUMBER ***SPECIFY FINISH	Satin	CLEAR ANODIZED	DARK BRONZE	BRONZE TONE, BLACK,	
												OR BLACK ANODIZED	WHITE, OR CLEAR POWDER COAT	
20'	5"	.156"	1	2'-0"	3"	4' x 6'	160	262	ISW20C51-***	\$3,451	\$4,108	\$4,187	\$3,735	
	5"	.188"	1	2'-0"	3"	4' x 6'	182	287	ISW20D51-***	\$3,752	\$4,457	\$4,536	\$4,036	
	6"	.156"	1	2'-0"	3.5"	4' x 6'	208	301	ISW20C61-***	\$4,043	\$4,816	\$4,910	\$4,375	
	6"	.188"	1	2'-0"	3.5"	4' x 6'	229	328	ISW20D61-***	\$4,668	\$5,541	\$5,635	\$5,000	
25'	5"	.156"	1	2'-6"	3"	5' x 8'	111	178	ISW25C51-***	\$3,818	\$4,555	\$4,650	\$4,160	
	5"	.188"	1	2'-6"	3"	5' x 8'	124	209	ISW25D51-***	\$4,442	\$5,279	\$5,374	\$4,784	
	6"	.156"	1	2'-6"	3.5"	5' x 8'	149	230	ISW25C61-***	\$4,585	\$5,471	\$5,583	\$4,985	
	6"	.188"	1	2'-6"	3.5"	5' x 8'	168	253	ISW25D61-***	\$4,868	\$5,799	\$5,912	\$5,268	
30'	5"	.156"	1	3'-0"	3"	6' x 10'	86	112	ISW30C51-***	\$4,076	\$4,885	\$5,004	\$4,502	
	5"	.156"	2	3'-0"	3"	6' x 10'	86	112	ISW30C52-***	\$4,202	\$5,031	\$5,150	\$4,628	
	5"	.188"	1	3'-0"	3"	6' x 10'	94	131	ISW30D51-***	\$4,660	\$5,562	\$5,681	\$5,086	
	5"	.188"	2	3'-0"	3"	6' x 10'	94	131	ISW30D52-***	\$4,817	\$5,744	\$5,863	\$5,243	
	6"	.156"	1	3'-0"	3.5"	6' x 10'	108	174	ISW30C61-***	\$4,855	\$5,821	\$5,962	\$5,353	
	6"	.156"	2	3'-0"	3.5"	6' x 10'	108	174	ISW30C62-***	\$4,984	\$5,971	\$6,111	\$5,482	
	6"	.188"	1	3'-0"	3.5"	6' x 10'	122	197	ISW30D61-***	\$5,025	\$6,019	\$6,159	\$5,523	
	6"	.188"	2	3'-0"	3.5"	6' x 10'	122	197	ISW30D62-***	\$5,143	\$6,155	\$6,296	\$5,641	
	35'	5"	.156"	1	3'-6"	3"	6' x 10'	73	87	ISW35C51-***	\$4,392	\$5,277	\$5,416	\$4,888
		5"	.156"	2	3'-6"	3"	6' x 10'	73	87	ISW35C52-***	\$4,556	\$5,468	\$5,606	\$5,052
5"		.188"	1	3'-6"	3"	6' x 10'	79	95	ISW35D51-***	\$5,060	\$6,052	\$6,191	\$5,556	
5"		.188"	2	3'-6"	3"	6' x 10'	79	95	ISW35D52-***	\$5,099	\$6,098	\$6,236	\$5,595	
6"		.156"	1	3'-6"	3.5"	6' x 10'	87	116	ISW35C61-***	\$5,210	\$6,265	\$6,428	\$5,791	
6"		.156"	2	3'-6"	3.5"	6' x 10'	87	116	ISW35C62-***	\$5,341	\$6,417	\$6,580	\$5,922	
6"		.188"	1	3'-6"	3.5"	6' x 10'	97	145	ISW35D61-***	\$5,684	\$6,815	\$6,978	\$6,265	
6"		.188"	2	3'-6"	3.5"	6' x 10'	97	145	ISW35D62-***	\$5,741	\$6,881	\$7,044	\$6,322	
7"		.156"	1	3'-6"	3.5"	6' x 10'	110	165	ISW35C71-***	\$5,899	\$7,099	\$7,287	\$6,565	
7"		.156"	2	3'-6"	3.5"	6' x 10'	110	165	ISW35C72-***	\$6,109	\$7,342	\$7,531	\$6,775	
40'	7"	.188"	1	3'-6"	3.5"	6' x 10'	127	187	ISW35D71-***	\$6,209	\$7,458	\$7,647	\$6,875	
	7"	.188"	2	3'-6"	3.5"	6' x 10'	127	187	ISW35D72-***	\$6,376	\$7,652	\$7,841	\$7,042	
	7"	.156"	1	4'-0"	3.5"	8' x 12'	87	122	ISW40C71-***	\$6,640	\$7,995	\$8,210	\$7,401	
	7"	.156"	2	4'-0"	3.5"	8' x 12'	87	122	ISW40C72-***	\$6,827	\$8,212	\$8,427	\$7,588	

*** - Finish Options
 SAT = Satin
 ACL = Anodized - Clear
 ADB = Anodized - Dark Bronze
 ABL = Anodized - Black
 BZT = Powder Coat - Bronze Tone
 BLK = Powder Coat - Black
 WHT = Powder Coat - White
 CLR = Powder Coat - Clear

Quantity Discounts
 5+ = 5% 8+ = 10% 15+ = 12%
 *Flagpoles From All Flagpole Series May Be Combined To Achieve Quantity Discounts.

SOVEREIGNTY SERIES - ISW OPTIONS

Cast Aluminum, SEALED Bearings, Gold Powder Coated Ball Truck
 Replaces Standard Truck and Ball Combination - See Page 68.

8" Diameter Ball/Truck Add \$164
 10" Diameter Ball/Truck Add \$220

Cast Aluminum FC-11 In Lieu of Spun Collar - See Page 81.
 5"-7" Butt Diameters Add \$67



Shoe Base Designs for Surface Mount Installations are available with all Sovereignty Series - ISW Flagpoles. See Page 14.
 5" Butt Diameters Add \$246
 6"-7" Butt Diameters Add \$304

Flagpole Lighting Options are available for all Sovereignty Series ISW Flagpoles - See Pages 84-91.

Independence Series - IRW

Internal Reinforced with Winch - Wire Halyard

The Independence Series from Concord American Flagpole is the perfect choice when your project calls for a commercial grade flagpole utilizing a heavy-duty Internal Halyard Winch and Wire Cable system. Offered in heights of 20' to 80', the reinforced welded door frame delivers exceptional strength, combining security with superior aesthetics achieved from a lockable flush mount door.

STANDARD FLAGPOLE ACCESSORIES - 6" TO 8" BUTT DIAMETERS

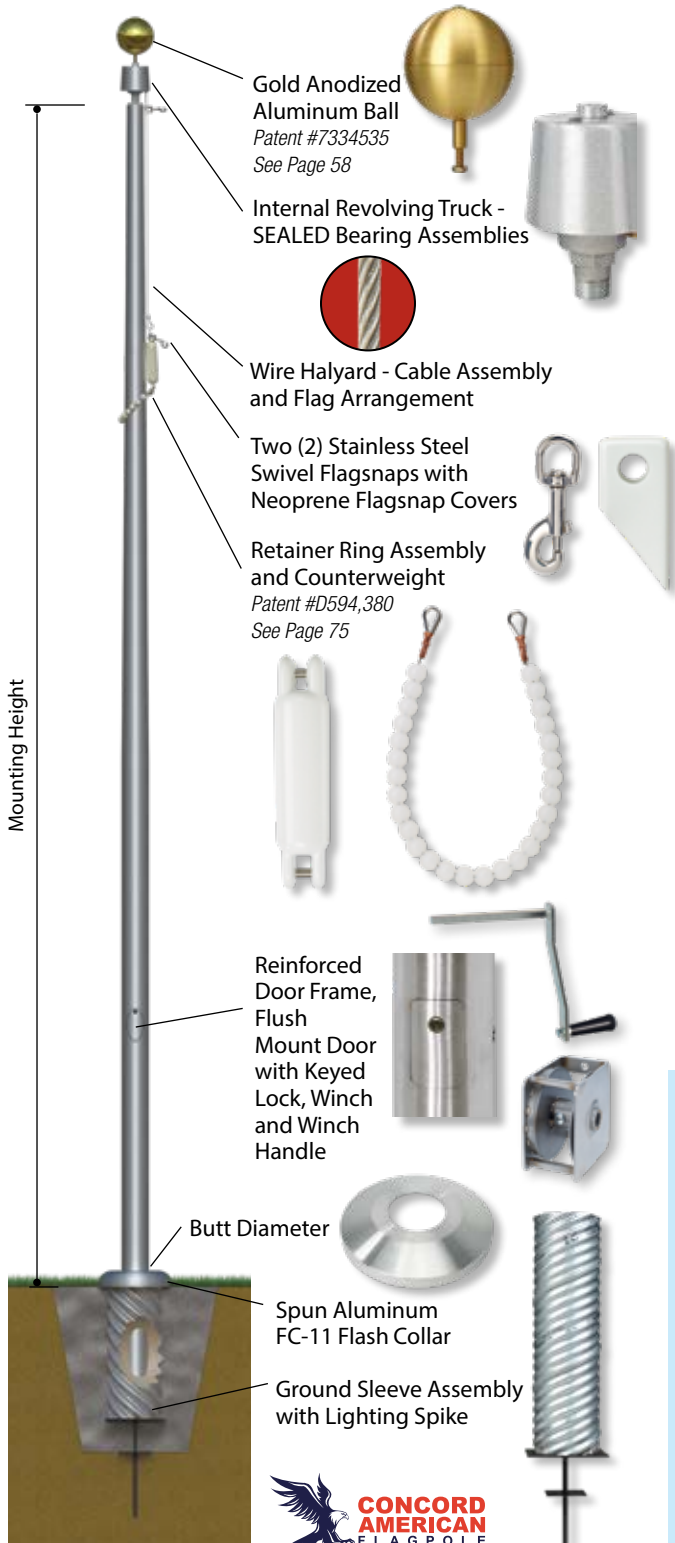

Standard Specifications

- Patented, Heavy-Duty Gold Anodized Aluminum Ball
- Cast Aluminum Revolving Truck with SEALED Stainless Steel Bearing Assemblies, Aluminum Spindle, Cast Brass Exit Bushing and Removable Hood
- Complete Internal Halyard Assembly
 - Wire Halyard Cable Assembly
 - Flag Arrangement (8' x 12' and Larger Flags Include Heavy-Duty Shock Spring Assembly)
 - Two (2) Stainless Steel Swivel Flagsnaps
 - Two (2) Neoprene Flagsnap Covers
 - Patented, Plastic Coated Counterweight
 - Beaded Retainer Ring Assembly
- Stainless Steel Winch Assembly with Removable Hand Crank
- Reinforced Door Frame
- Flush Mount Access Door with Lock and Keys
- Spun Aluminum FC-11 Flash Collar
- Galvanized 16-Gauge Corrugated Steel Ground Sleeve with Steel Grounding Spike

Standard Upgrades - 10" & 12" Butt Dia. 40' to 80'

- Heavy-Duty Dual SEALED Bearing Truck
- Two (2) Heavy-Duty Stainless Steel Flagsnaps with Covers
- Heavy-Duty Cast Aluminum FC-11 Flash Collar
- Heavy-Duty 5/8" Ball Stem

Reinforced Welded Door Frame

Independence Flagpoles are engineered with an inset reinforced aluminum door frame welded into the precision cut door opening, providing additional strength and higher max wind speeds from each butt diameter/wall thickness combination. The efficiency of this design produces maximum strength-to-size ratios while providing a smooth, flush fitting door, making Independence IRW flagpoles the ideal choice in many applications.



Independence Series - IRW Internal Reinforced with Winch - Wire Halyard

MTG HGT.	BUTT DIA.	WALL THICKNESS	POLE SECTIONS	SET DEPTH	TOP DIAM.	STD FLAG SIZE	MAX WIND SPEED WITH NYLON	MAX WIND FLAG SPEED NO FLAG	CATALOG NUMBER ***SPECIFY FINISH	Satin	CLEAR ANODIZED	DARK BRONZE OR BLACK ANODIZED	BRONZE TONE, BLACK, WHITE, OR CLEAR POWDER COAT
20'	6"	.156"	1	2'-0"	3.5"	4' x 6'	208	301	IRW20C61-***	\$4,604	\$5,467	\$5,561	\$4,936
	6"	.188"	1	2'-0"	3.5"	4' x 6'	229	328	IRW20D61-***	\$5,179	\$6,134	\$6,228	\$5,511
25'	6"	.156"	1	2'-6"	3.5"	5' x 8'	149	230	IRW25C61-***	\$5,163	\$6,141	\$6,254	\$5,563
	6"	.188"	1	2'-6"	3.5"	5' x 8'	168	253	IRW25D61-***	\$5,364	\$6,375	\$6,487	\$5,764
30'	6"	.156"	1	3'-0"	3.5"	6' x 10'	108	174	IRW30C61-***	\$5,479	\$6,545	\$6,685	\$5,977
	6"	.156"	2	3'-0"	3.5"	6' x 10'	108	174	IRW30C62-***	\$5,729	\$6,835	\$6,975	\$6,227
	6"	.188"	1	3'-0"	3.5"	6' x 10'	122	197	IRW30D61-***	\$5,931	\$7,070	\$7,210	\$6,429
	6"	.188"	2	3'-0"	3.5"	6' x 10'	122	197	IRW30D62-***	\$6,142	\$7,314	\$7,454	\$6,640
	7"	.188"	1	3'-0"	3.5"	6' x 10'	157	235	IRW30D71-***	\$6,364	\$7,602	\$7,763	\$6,935
	7"	.188"	2	3'-0"	3.5"	6' x 10'	157	235	IRW30D72-***	\$6,628	\$7,908	\$8,069	\$7,199
35'	6"	.156"	1	3'-6"	3.5"	6' x 10'	87	116	IRW35C61-***	\$6,011	\$7,194	\$7,357	\$6,592
	6"	.156"	2	3'-6"	3.5"	6' x 10'	87	116	IRW35C62-***	\$6,206	\$7,420	\$7,584	\$6,787
	6"	.188"	1	3'-6"	3.5"	6' x 10'	97	145	IRW35D61-***	\$6,465	\$7,721	\$7,884	\$7,046
	6"	.188"	2	3'-6"	3.5"	6' x 10'	97	145	IRW35D62-***	\$6,676	\$7,965	\$8,129	\$7,257
	7"	.156"	1	3'-6"	3.5"	6' x 10'	110	165	IRW35C71-***	\$6,757	\$8,094	\$8,283	\$7,423
	7"	.156"	2	3'-6"	3.5"	6' x 10'	110	165	IRW35C72-***	\$6,983	\$8,356	\$8,545	\$7,649
	7"	.188"	1	3'-6"	3.5"	6' x 10'	127	187	IRW35D71-***	\$7,009	\$8,386	\$8,575	\$7,675
	7"	.188"	2	3'-6"	3.5"	6' x 10'	127	187	IRW35D72-***	\$7,162	\$8,564	\$8,752	\$7,828
	8"	.188"	1	3'-6"	4"	6' x 10'	155	213	IRW35D81-***	\$7,411	\$8,889	\$9,108	\$8,161
40'	7"	.156"	1	4'-0"	3.5"	8' x 12'	87	122	IRW40C71-***	\$7,462	\$8,948	\$9,164	\$8,223
	7"	.156"	2	4'-0"	3.5"	8' x 12'	87	122	IRW40C72-***	\$7,527	\$9,024	\$9,239	\$8,288
	7"	.188"	1	4'-0"	3.5"	8' x 12'	103	147	IRW40D71-***	\$7,583	\$9,089	\$9,304	\$8,344
	8"	.156"	1	4'-0"	4"	8' x 12'	107	157	IRW40C81-***	\$7,735	\$9,307	\$9,557	\$8,593
	8"	.156"	2	4'-0"	3.5"	8' x 12'	107	157	IRW40C82-***	\$7,771	\$9,349	\$9,599	\$8,629
	8"	.188"	1	4'-0"	4"	8' x 12'	123	177	IRW40D81-***	\$8,034	\$9,654	\$9,904	\$8,892
	8"	.188"	2	4'-0"	3.5"	8' x 12'	122	177	IRW40D82-***	\$8,188	\$9,832	\$10,082	\$9,046
	10"	.188"	2	4'-0"	4"	8' x 12'	166	226	IRW40D12-***	\$9,030	\$10,889	\$11,203	\$10,081
45'	8"	.188"	2	4'-6"	3.5"	8' x 12'	102	144	IRW45D82-***	\$9,260	\$11,118	\$11,399	\$10,225
	8"	.250"	2	4'-6"	3.5"	8' x 12'	125	173	IRW45F82-***	\$9,460	\$11,350	\$11,631	\$10,425
	10"	.188"	2	4'-6"	4"	8' x 12'	143	192	IRW45D12-***	\$9,583	\$11,582	\$11,936	\$10,766
50'	8"	.188"	3	5'-0"	3.5"	10' x 15'	83	117	IRW50D83-***	\$9,524	\$11,466	\$11,778	\$10,596
	10"	.188"	3	5'-0"	4"	10' x 15'	118	164	IRW50D13-***	\$11,279	\$13,601	\$13,994	\$12,593
	10"	.250"	3	5'-0"	4"	10' x 15'	140	191	IRW50F13-***	\$11,361	\$13,696	\$14,089	\$12,675
55'	10"	.188"	3	5'-6"	4"	10' x 15'	102	139	IRW55D13-***	\$12,129	\$14,639	\$15,071	\$13,574
60'	10"	.188"	3	6'-0"	4"	12' x 18'	86	118	IRW60D13-***	\$12,784	\$15,450	\$15,922	\$14,361
	10"	.250"	3	6'-0"	4"	12' x 18'	104	143	IRW60F13-***	\$15,843	\$18,999	\$19,470	\$17,420
	12"	.250"	3	6'-0"	4"	12' x 18'	137	187	IRW60F23-***	\$19,055	\$22,847	\$23,423	\$20,837
65'	12"	.250"	3	6'-6"	4"	12' x 18'	122	165	IRW65F23-***	\$20,382	\$24,448	\$25,072	\$22,313
70'	12"	.250"	3	7'-0"	4"	12' x 18'	109	145	IRW70F23-***	\$20,957	\$25,177	\$25,849	\$23,036
	12"	.375"	3	7'-0"	4"	12' x 18'	139	181	IRW70H23-***	\$21,439	\$25,736	\$26,408	\$23,518
75'	12"	.375"	3	7'-6"	4"	12' x 18'	126	161	IRW75H23-***	\$23,543	\$28,239	\$28,958	\$25,771
80'	12"	.375"	3	8'-0"	4"	15' x 25'	107	144	IRW80H23-***	\$26,377	\$31,588	\$32,356	\$28,753

*** - Finish Options

- SAT = Satin
- ACL = Anodized - Clear
- ADB = Anodized - Dark Bronze
- ABL = Anodized - Black
- BZT = Powder Coat - Bronze Tone
- BLK = Powder Coat - Black
- WHT = Powder Coat - White
- CLR = Powder Coat - Clear

Quantity Discounts

- 5+ = 5%
- 8+ = 10%
- 15+ = 12%
- *Flagpoles From All Flagpole Series May Be Combined To Achieve Quantity Discounts.

INDEPENDENCE SERIES - IRW OPTIONS



Cast Aluminum, SEALED Bearings, Gold Powder Coated Ball Truck
Replaces Standard Truck and Ball Combination - See Page 68.

8" Diameter Ball/Truck Add \$164
10" Diameter Ball/Truck Add \$220
12" Diameter Ball/Truck Add \$395



Cast Aluminum FC-11 In Lieu of Spun Collar - See Page 81.
6"-7" Butt Diameters Add \$67
8" Butt Diameters Add \$201

Flagpole Lighting Options are available for all Independence Series IRW Flagpoles - See Pages 84-91.

Shoe Base Designs for Surface Mount Installations are available for 20' to 80' - IRW Flagpoles. See Page 14.
6"-8" Butt Diameters...Add \$304
10" Butt Diameters.....Add \$608
12" Butt Diameters...Add \$1,209

Flagpole Lighting Options are available for all Independence Series IRW Flagpoles - See Pages 84-91.



Xtreme Series - XIWW

Xtreme Internal With Winch - Wire Halyard

The Xtreme Series XIWW from Concord American Flagpole provides the strength of our Xtreme Series Flush Mount Hinged Doorwith Internal Revolving Design in heights of 25' to 60'.

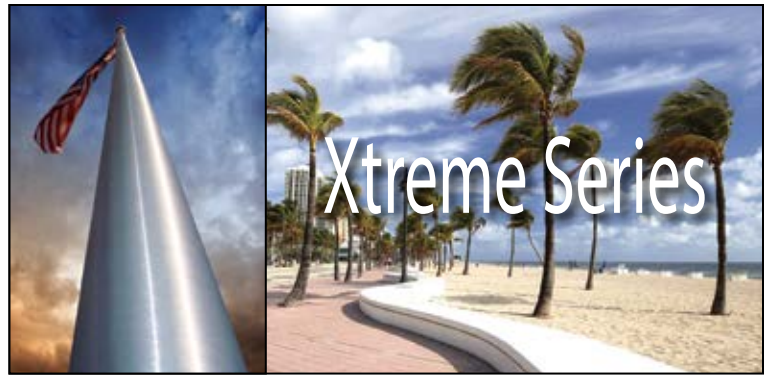

STANDARD FLAGPOLE ACCESSORIES - 7" TO 12" BUTT DIAMETERS

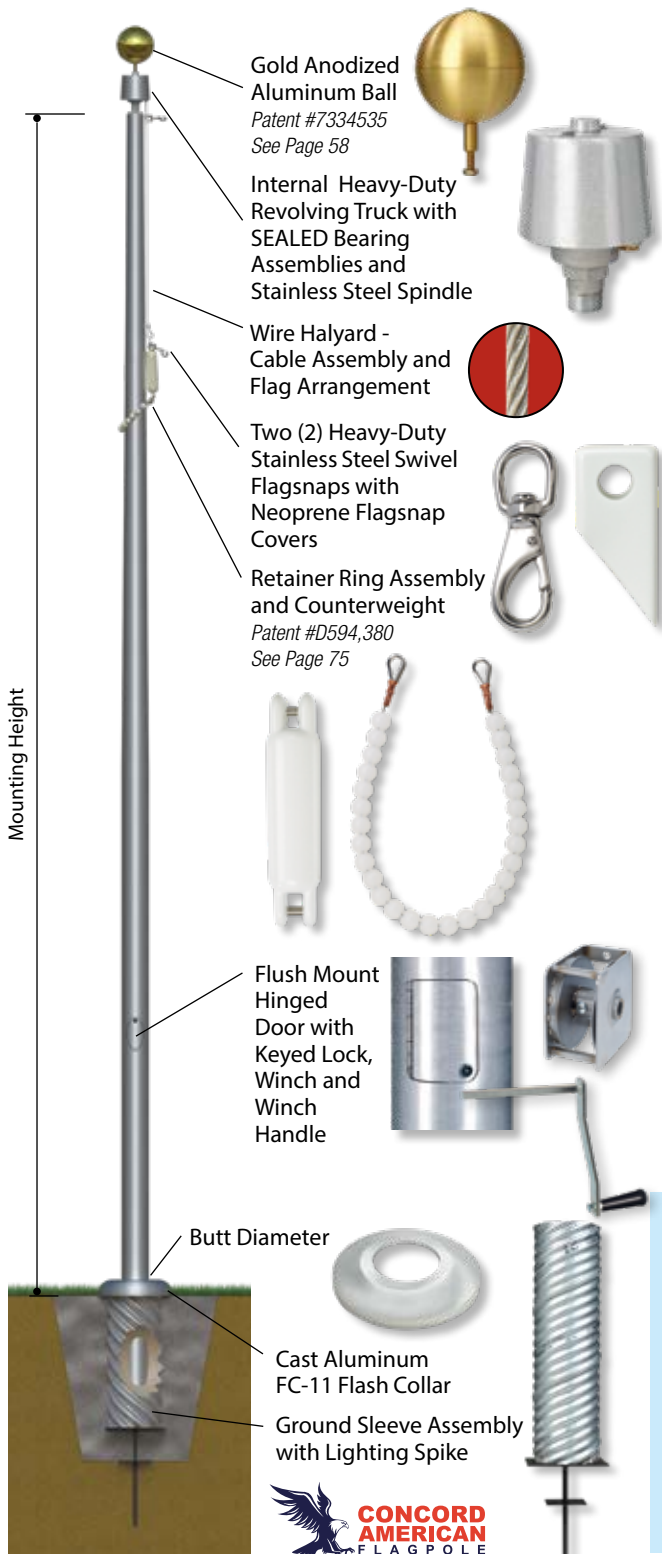

XIWW – Xtreme Internal Single Revolving

The Xtreme Series from Concord American Flagpole provides flagpole owners with the Increased Wind Speed Ratings necessary in coastal, high wind, oversized and multiple flag applications. Years of Engineering, R & D and Manufacturing experience have merged to create the strongest, most efficient increased wind speed flagpoles, combining superior strength with the highest quality Heavy-Duty Component Parts in the industry...Internal Revolving Trucks with SEALED Bearing Assemblies and Stainless Steel Spindle, Stainless Steel Swivel Flagsnaps and Cast Aluminum Collars.

Standard Specifications

- Patented, Heavy-Duty Gold Anodized Aluminum Ball
- Heavy-Duty Cast Aluminum Revolving Truck with SEALED Stainless Steel Bearing Assemblies, Stainless Steel Spindle, Cast Brass Exit Bushing and Removable Hood
- Complete Internal Halyard Assembly
 - Wire Halyard Cable Assembly
 - Flag Arrangement (8' x 12' and Larger Flags Include Heavy-Duty Shock Spring Assembly)
 - Two (2) Heavy-Duty Stainless Steel Swivel Flagsnaps
 - Two (2) Neoprene Flagsnap Covers
 - Patented, Plastic Coated Counterweight
 - Beaded Retainer Ring Assembly
- Stainless Steel Winch Assembly with Removable Hand Crank
- Flush Mount Access Door with Lock and Keys
- Heavy-Duty Cast Aluminum FC-11 Flash Collar
- Galvanized 16-Gauge Corrugated Steel Ground Sleeve with Steel Grounding Spike

Standard Upgrades – 10" and 12" Butt Diameters

- Heavy-Duty 5/8" Ball Stem
- Two (2) Heavy-Duty 4-1/4" Stainless Steel Flagsnaps with Covers

Flush Mount Hinged Door Design

Xtreme XIWW Flagpoles unite the simplicity of efficient engineering with the aesthetics of a precision cut, rectangular flush mount door design, providing an internal halyard Winch system that is ideal for many extreme wind speed applications.



Xtreme Series - XIWW Internal With Winch - Wire Halyard

MTG HGT.	BUTT DIA.	WALL THICKNESS	POLE SECTIONS	SET DEPTH	TOP DIAM.	STD FLAG SIZE	MAX WIND SPEED WITH NYLON	MAX WIND SPEED NO FLAG	CATALOG NUMBER ***SPECIFY FINISH	Satin	CLEAR ANODIZED	DARK BRONZE OR BLACK ANODIZED	BRONZE TONE, BLACK, WHITE, OR CLEAR POWDERCOAT
25'	7"	.250"	1	2'-6"	3.5"	5' x 8'	190	294	XIWW25F71-***	\$5,707	\$6,796	\$6,926	\$6,165
30'	8"	.250"	1	3'-0"	4"	6' x 10'	178	269	XIWW30F81-***	\$6,347	\$7,613	\$7,801	\$6,990
	8"	.250"	2	3'-0"	3.5"	6' x 10'	178	269	XIWW30F82-***	\$6,982	\$8,350	\$8,538	\$7,625
40'	10"	.250"	2	4'-0"	4"	8' x 12'	166	234	XIWW40F12-***	\$8,527	\$10,305	\$10,620	\$9,578
50'	12"	.250"	3	5'-0"	4"	10' x 15'	158	222	XIWW50F23-***	\$10,415	\$12,701	\$13,181	\$11,900
60'	12"	.375"	3	6'-0"	4"	12' x 18'	149	205	XIWW60H23-***	\$15,625	\$18,868	\$19,444	\$17,407

*** - Finish Options

- SAT = Satin
- ACL = Anodized - Clear
- ADB = Anodized - Dark Bronze
- ABL = Anodized - Black
- BZT = Powder Coat - Bronze Tone
- BLK = Powder Coat - Black
- WHT = Powder Coat - White
- CLR = Powder Coat - Clear

Quantity Discounts

5+ = 5% 8+ = 10% 15+ = 12%
 *Flagpoles From All Flagpole Series May Be Combined To Achieve Quantity Discounts.

XTREME SERIES XIWW OPTIONS

Cast Aluminum, SEALED Bearings, Gold Powder Coated Ball Truck
 Replaces Standard Truck and Ball Combination - See Page 68.

8" Diameter Ball/Truck Add \$164
 10" Diameter Ball/Truck Add \$220
 12" Diameter Ball/Truck Add \$395



Shoe Base Designs for Surface Mount Installations are available with all Xtreme Series - XIWW Flagpoles. See Page 14.
 7"-8" Butt Diameters Add \$304
 10" Butt Diameters Add \$608
 12" Butt Diameters Add \$1,209

Flagpole Lighting Options are available for all Xtreme Series XIWW Flagpoles - See Pages 84-91.

Our INDUSTRY-FIRST Lifetime Flagpole Shaft Warranty assures that a Concord American Flagpole Xtreme Series Flagpole will stand the worst Mother Nature can throw at it... Guaranteed!

Xtreme Series - XIRW

Xtreme Internal Reinforced with Winch - Wire Halyard

The Xtreme Series XIRW from Concord American Flagpole provides the strength of our Xtreme Series Reinforced Welded Door Frame with Internal Revolving Design in heights of 25' to 70'.



STANDARD FLAGPOLE ACCESSORIES - 6" TO 12" BUTT DIAMETERS

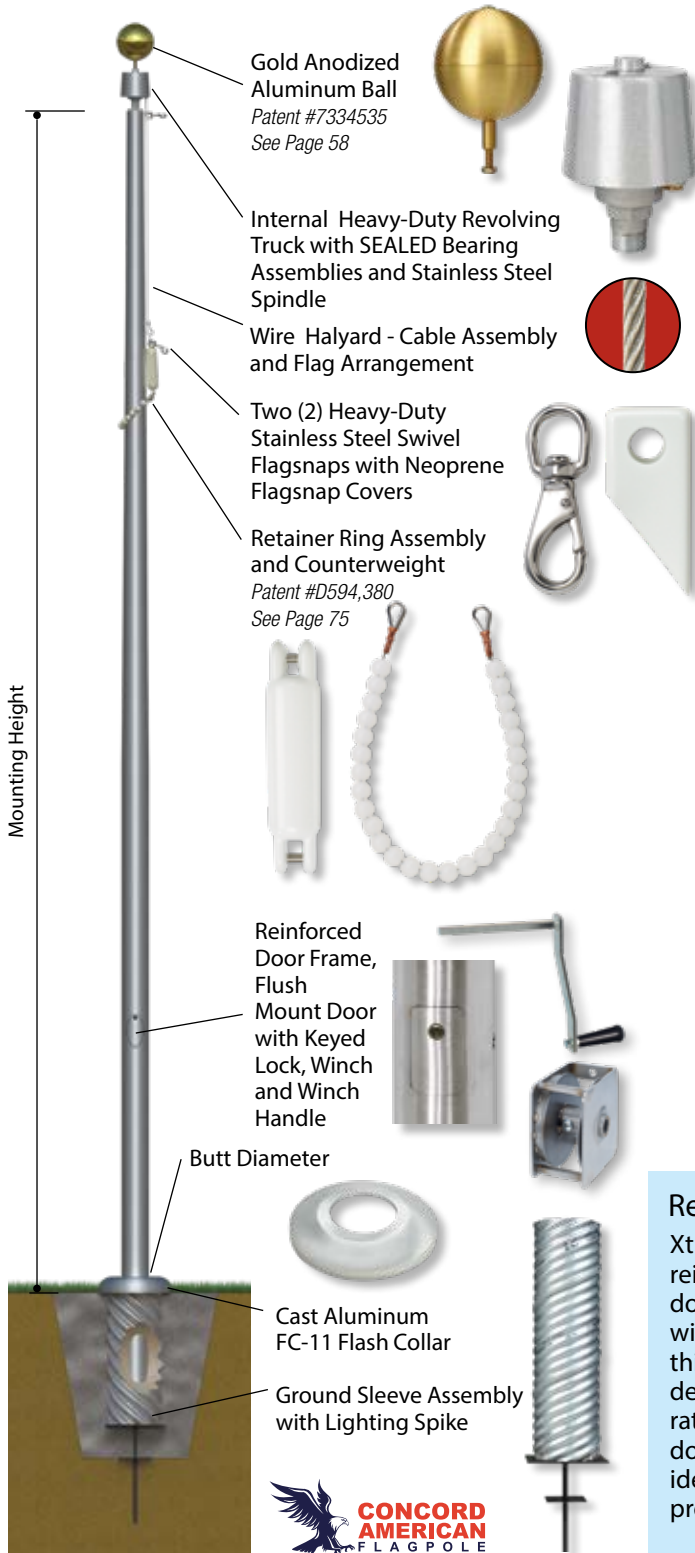

XIRW – Xtreme Internal Reinforced with Winch
 The Xtreme Series from Concord American Flagpole provides flagpole owners with the Increased Wind Speed Ratings necessary in coastal, high wind, oversized and multiple flag applications. Years of Engineering, R & D and Manufacturing experience have merged to create the strongest, most efficient increased wind speed flagpoles, combining superior strength with the highest quality Heavy-Duty Component Parts in the industry...Internal Revolving Trucks with SEALED Bearing Assemblies and Stainless Steel Spindle, Stainless Steel Swivel Flagnaps and Cast Aluminum Collars.

Standard Specifications

- Patented, Heavy-Duty Gold Anodized Aluminum Ball
- Heavy-Duty Cast Aluminum Revolving Truck with SEALED Stainless Steel Bearing Assemblies, Stainless Steel Spindle, Cast Brass Exit Bushing and Removable Hood
- Complete Internal Halyard Assembly
 - Wire Halyard Cable Assembly
 - Flag Arrangement (8' x 12' and Larger Flags Include Heavy-Duty Shock Spring Assembly)
 - Two (2) Heavy-Duty Stainless Steel Swivel Flagnaps
 - Two (2) Neoprene Flagnap Covers
 - Patented, Plastic Coated Counterweight
 - Beaded Retainer Ring Assembly
- Stainless Steel Winch Assembly with Removable Hand Crank
- Reinforced Door Frame
- Flush Mount Access Door with Lock and Keys
- Heavy-Duty Cast Aluminum FC-11 Flash Collar
- Galvanized 16-Gauge Corrugated Steel Ground Sleeve with Steel Grounding Spike

Standard Upgrades – 10" and 12" Butt Diameters

- Heavy-Duty 5/8" Ball Stem
- Two (2) Heavy-Duty 4-1/4" Stainless Steel Flagnaps with Covers

Reinforced Welded Door Frame

Xtreme Series XIRW Flagpoles are engineered with an inset reinforced aluminum door frame welded into the precision cut door opening, providing additional strength and higher max wind speeds from each butt diameter/wall thickness combination. The efficiency of this design produces maximum strength-to-size ratios while providing a smooth, flush fitting door, making Xtreme XIRW flagpoles the ideal choice for the most extreme flagpole projects.



Xtreme Series - XIRW Xtreme Internal Reinforced with Winch - Wire Halyard

MTG HGT.	BUTT DIA.	WALL THICKNESS	POLE SECTIONS	SET DEPTH	TOP DIAM.	STD FLAG SIZE	MAX WIND SPEED WITH NYLON	MAX WIND SPEED NO FLAG	CATALOG NUMBER ***SPECIFY FINISH	Satin	CLEAR ANODIZED	DARK BRONZE OR BLACK ANODIZED	BRONZE TONE, BLACK, WHITE, OR CLEAR POWDER COAT
25'	6"	.250"	1	2'6"	3.5"	5' x 8'	197	287	XIRW25F61-***	\$6,150	\$7,286	\$7,399	\$6,550
30'	6"	.250"	1	3'0"	3.5"	6' x 10'	150	229	XIRW30F61-***	\$6,943	\$8,243	\$8,384	\$7,441
	6"	.250"	2	3'0"	3.5"	6' x 10'	150	229	XIRW30F62-***	\$7,292	\$8,648	\$8,788	\$7,790
	7"	.188"	1	3'0"	3.5"	6' x 10'	157	235	XIRW30D71-***	\$6,271	\$7,494	\$7,655	\$6,842
	7"	.188"	2	3'0"	3.5"	6' x 10'	157	235	XIRW30D72-***	\$6,583	\$7,856	\$8,017	\$7,154
	7"	.250"	1	3'0"	3.5"	6' x 10'	194	269	XIRW30F71-***	\$7,388	\$8,790	\$8,951	\$7,959
35'	8"	.250"	1	3'6"	4"	6' x 10'	181	249	XIRW35F81-***	\$7,688	\$9,211	\$9,429	\$8,438
	8"	.250"	2	3'6"	3.5"	6' x 10'	181	249	XIRW35F82-***	\$8,092	\$9,679	\$9,898	\$8,842
40'	8"	.250"	1	4'0"	4"	8' x 12'	146	205	XIRW40F81-***	\$8,633	\$10,349	\$10,599	\$9,491
	8"	.250"	2	4'0"	3.5"	8' x 12'	146	207	XIRW40F82-***	\$9,224	\$11,034	\$11,284	\$10,082
	10"	.250"	2	4'0"	4"	8' x 12'	192	259	XIRW40F12-***	\$10,406	\$12,485	\$12,799	\$11,457
45'	10"	.250"	2	4'6"	4"	8' x 12'	168	226	XIRW45F12-***	\$11,587	\$13,907	\$14,260	\$12,770
50'	10"	.250"	3	5'0"	4"	10' x 15'	140	191	XIRW50F13-***	\$12,340	\$14,832	\$15,225	\$13,654
	12"	.250"	3	5'0"	4"	10' x 15'	179	242	XIRW50F23-***	\$15,042	\$18,068	\$18,548	\$16,527
60'	12"	.375"	3	6'0"	4"	12' x 18'	171	228	XIRW60H23-***	\$21,928	\$26,180	\$26,755	\$23,710
70'	12"	.375"	3	7'0"	4"	12' x 18'	139	181	XIRW70H23-***	\$24,274	\$29,025	\$29,696	\$26,353

*** - Finish Options

- SAT = Satin
- ACL = Anodized - Clear
- ADB = Anodized - Dark Bronze
- ABL = Anodized - Black
- BZT = Powder Coat - Bronze Tone
- BLK = Powder Coat - Black
- WHT = Powder Coat - White
- CLR = Powder Coat - Clear

Quantity Discounts

- 5+ = 5% 8+ = 10% 15+ = 12%
- *Flagpoles From All Flagpole Series May Be Combined To Achieve Quantity Discounts.

XTREME SERIES - XIRW OPTIONS

Cast Aluminum, SEALED Bearings, Gold Powder Coated Ball Truck
Replaces Standard Truck and Ball Combination - See Page 68.

8" Diameter Ball/Truck Add \$164
10" Diameter Ball/Truck Add \$220
12" Diameter Ball/Truck Add \$395



Shoe Base Designs for Surface Mount Installations are available with all Xtreme Series - XIRW Flagpoles. See Page 14.

- 6"-8" Butt Diameters Add \$304
- 10" Butt Diameters Add \$608
- 12" Butt Diameters Add \$1,209

Flagpole Lighting Options are available for all Xtreme Series XIRW Flagpoles - See Pages 84-91.

Our INDUSTRY-FIRST Lifetime Flagpole Shaft Warranty assures that a Concord American Flagpole Xtreme Series Flagpole will withstand the worst Mother Nature can throw at it... Guaranteed!

APEX™ Series - IRW

100' Internal Reinforced with Winch – Wire

Concord American Flagpole's expert engineering capabilities have led to the development of another industry first... a **100' aluminum flagpole in a 12" butt diameter**. The advantages of aluminum when compared to steel alternatives are substantial. Aluminum is corrosion resistant, lightweight, and provides lower overall cost of ownership. Additionally, our 12" butt diameter design significantly lowers installation costs when compared to competitor's 16" + butt diameter aluminum flagpoles.

STANDARD FLAGPOLE ACCESSORIES - 12" BUTT DIAMETER

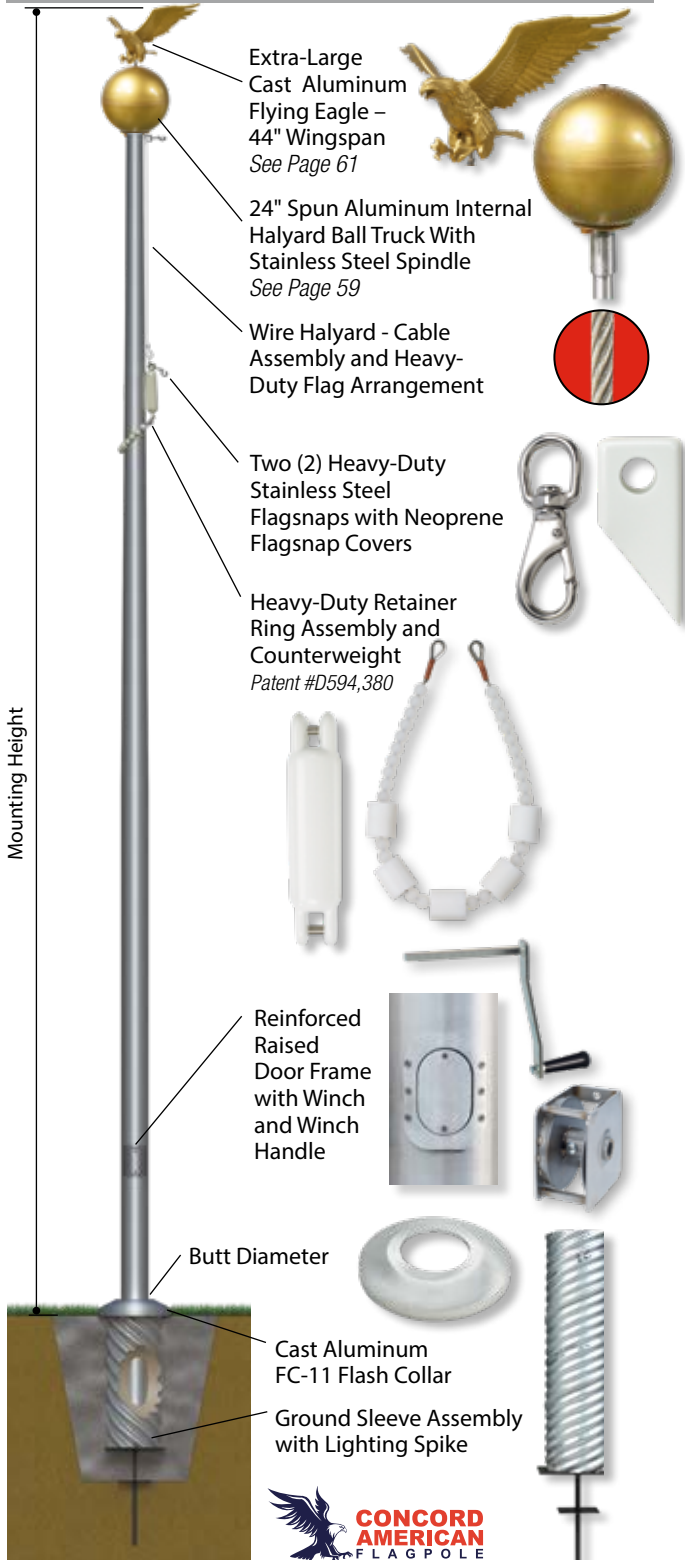

MAKE A LANDMARK DECISION

Standard Specifications

- Extra-Large Cast Aluminum Flying Eagle – 44" Wingspan
- Spun Aluminum Revolving Ball Truck with Dual SEALED Stainless Steel Bearing Assemblies, Stainless Steel Spindle, Cast Brass Exit Bushing and Removable Hood
- Complete Internal Halyard Assembly
 - Wire Halyard Cable Assembly
 - Heavy-Duty 20' x 30' Flag Arrangement with Shock Spring Assembly
 - Two (2) Heavy-Duty Stainless Steel Swivel Flagnaps
 - Two (2) Neoprene Flagnap Covers
 - Patented, Plastic Coated Counterweight
 - Heavy-Duty Beaded Retainer Ring Assembly
- Stainless Steel Winch Assembly with Removable Hand Crank
- Reinforced Raised Door Frame
- Flush Mount Access Door with two (2) Tamper Proof Screws
- Cast Aluminum FC-11 Flash Collar
- Galvanized 16-Gauge Corrugated Steel Ground Sleeve with Steel Grounding Spike



Reinforced Welded Door Frame

APEX Flagpoles are designed with a raised reinforced door frame consisting of a matched set of inner AND outer castings. The aluminum door is secured with two (2) tamper-proof 1/4-20NC screws.



APEX™ Series - IRW 100' Internal Reinforced with Winch – Wire Halyard

MTG HGT.	BUTT DIA.	WALL THICKNESS	POLE SECTIONS	SET DEPTH	TOP DIAM.	STD FLAG SIZE	MAX WIND SPEED WITH NYLON FLAG	MAX WIND SPEED NO FLAG	CATALOG NUMBER ***SPECIFY FINISH	Satin	CLEAR ANODIZED	DARK BRONZE OR BLACK ANODIZED	BRONZE TONE, BLACK, WHITE, OR CLEAR POWDER COAT
100'	12"	.500"	4	9'-6"	4"	20' x 30'	90	128	IRW100I24-***	\$34,435	\$41,183	\$42,142	\$37,405

*** - Finish Options

- SAT = Satin
- ACL = Anodized - Clear
- ADB = Anodized - Dark Bronze
- ABL = Anodized - Black
- BZT = Powder Coat - Bronze Tone
- BLK = Powder Coat - Black
- WHT = Powder Coat - White
- CLR = Powder Coat - Clear

- Lower Freight and Installation Costs
- No Welding Required
- Lower Lifetime Cost of Ownership
- Will Never Rust
- No Painting Required
- Lifetime Flagpole Warranty

Flagpole Lighting Options are available for APEX Series IRW Flagpoles – See Pages 84-91.



Internal Halyard American XL Beacon Plus Winch System - Wire Halyard
 14" IH XL 12V - 1072 Lumens
 Part Number ABWA-A06S-***
 Satin.....Add \$8,460
 Powder Coat.....Add \$8,575



Nautical Single Mast Series - NSM

External Single Revolving with Yardarm - Rope Halyard

The Nautical Single Mast Series from Concord American Flagpole offers a nautical theme design incorporating a single shaft with yardarm in mounting heights from 25' to 80'. While most popular in coastal and marine settings, the multiple halyard design is the perfect option when a multiple flag design is desired. The addition of an optional Gaff increases design possibilities.

STANDARD FLAGPOLE ACCESSORIES - 5" TO 8" BUTT DIAMETERS

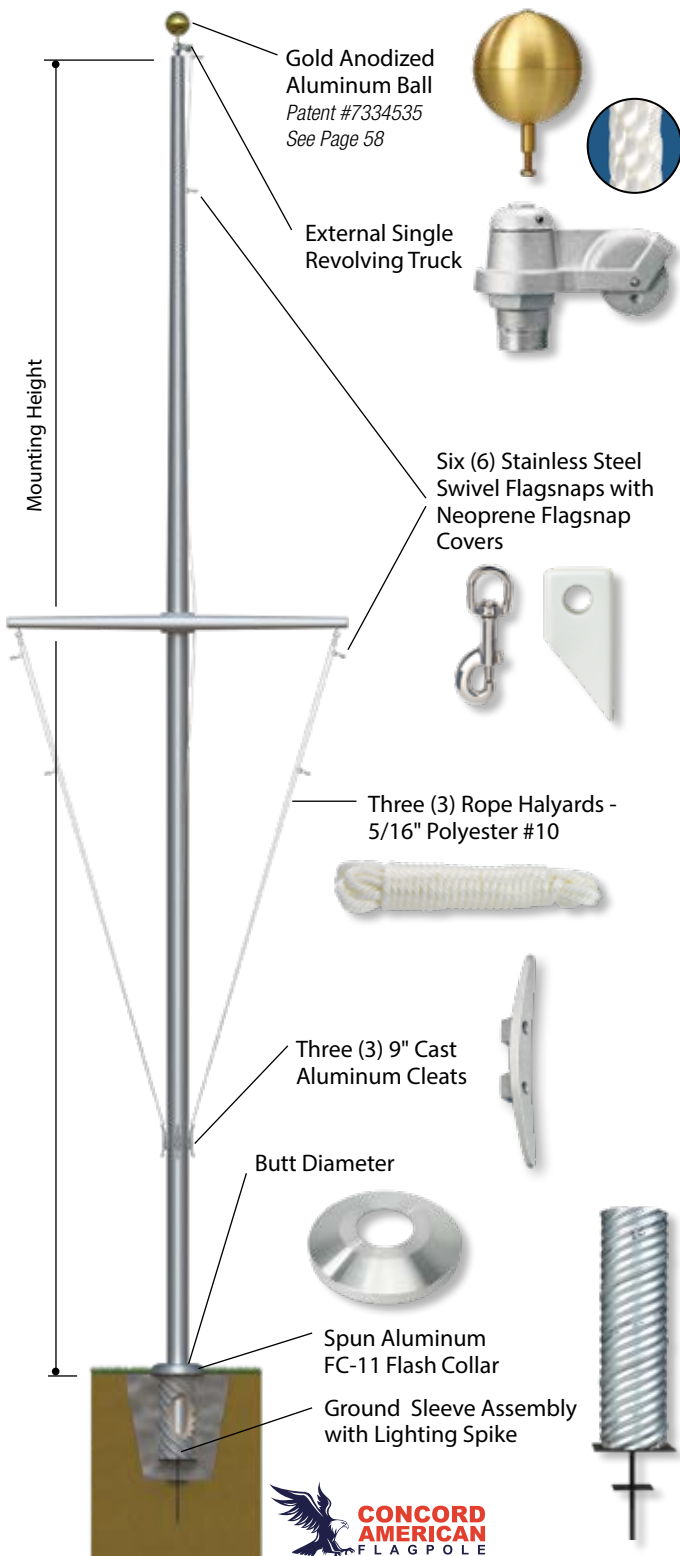

Standard Specifications

- Gold Anodized Aluminum Ball
- Cast Aluminum Single Revolving Truck Assembly with Aluminum Pulley
- Two (2) Eye Hook mounted Single Pulleys on Yardarm
- Complete External Halyard Assembly
 - Three (3) Rope Halyards - 5/16" #10 Polyester
 - Six (6) Stainless Steel Swivel Flagnaps
 - Six (6) Neoprene Flagnap Covers
- Three (3) 9" Heavy-Duty Aluminum Cleats
- Spun Aluminum FC-11 Flash Collar
- Galvanized 16-Gauge Corrugated Steel Ground Sleeve with Steel Grounding Spike

Standard Upgrades - 10" and 12" Butt Diameters

- Heavy-Duty Truck with Dual SEALED Bearing Assemblies
- Three (3) Rope Halyards - Heavy-Duty 3/8" #12 Polyester
- Six (6) Heavy-Duty Stainless Steel Flagnaps with Covers
- Heavy-Duty 5/8" Ball Stem
- Heavy-Duty Cast Aluminum Collar

Nautical Single Mast Series - NSM External Single Revolving with Yardarm - Rope Halyard

MTG HGT.	BUTT DIA.	WALL THICKNESS	POLE SECTIONS	SET DEPTH	TOP DIAM.	YARDARM LENGTH	CATALOG NUMBER ***SPECIFY FINISH	Satin	BRONZE TONE, BLACK, WHITE, OR CLEAR POWDERCOAT
25'	5"	.125"	1	2'6"	3"	8'0"	NSM25B51-***	\$3,447	\$3,892
	5"	.156"	1	2'6"	3"	8'0"	NSM25C51-***	\$3,878	\$4,323
	6"	.156"	1	2'6"	3.5"	8'0"	NSM25C61-***	\$4,532	\$5,053
30'	5"	.125"	1	3'0"	3"	8'0"	NSM30B51-***	\$3,878	\$4,407
	5"	.156"	1	3'0"	3"	8'0"	NSM30C51-***	\$4,223	\$4,752
	5"	.156"	2	3'0"	3"	8'0"	NSM30C52-***	\$4,645	\$5,174
	6"	.156"	1	3'0"	3.5"	8'0"	NSM30C61-***	\$4,705	\$5,324
	6"	.156"	2	3'0"	3.5"	8'0"	NSM30C62-***	\$4,861	\$5,480
	6"	.188"	1	3'0"	3.5"	8'0"	NSM30D61-***	\$5,174	\$5,793
	6"	.188"	2	3'0"	3.5"	8'0"	NSM30D62-***	\$5,205	\$5,824
35'	6"	.156"	1	3'6"	3.5"	9'6"	NSM35C61-***	\$5,420	\$6,144
	6"	.156"	2	3'6"	3.5"	9'6"	NSM35C62-***	\$5,480	\$6,204
	7"	.156"	1	3'6"	3.5"	9'6"	NSM35C71-***	\$5,726	\$6,556
	7"	.156"	2	3'6"	3.5"	9'6"	NSM35C72-***	\$6,028	\$6,858
	7"	.188"	1	3'6"	3.5"	9'6"	NSM35D71-***	\$6,354	\$7,184
	7"	.188"	2	3'6"	3.5"	9'6"	NSM35D72-***	\$6,635	\$7,465
40'	8"	.156"	1	4'0"	4"	10'9"	NSM40C81-***	\$7,394	\$8,461
	8"	.156"	2	4'0"	3.5"	10'9"	NSM40C82-***	\$7,599	\$8,666
	8"	.188"	1	4'0"	4"	10'9"	NSM40D81-***	\$7,867	\$8,934
	8"	.188"	2	4'0"	3.5"	10'9"	NSM40D82-***	\$8,360	\$9,427
50'	8"	.188"	3	5'-0"	4"	13'6"	NSM50D83-***	\$9,007	\$10,342
	10"	.188"	3	5'-0"	4"	13'6"	NSM50D13-***	\$10,560	\$12,196
60'	10"	.188"	3	6'-0"	4"	16'0"	NSM60D13-***	\$11,863	\$13,822
	10"	.250"	3	6'-0"	4"	16'0"	NSM60F13-***	\$14,700	\$16,659
	12"	.250"	3	6'-0"	4"	16'0"	NSM60F23-***	\$17,623	\$19,837
70'	12"	.250"	3	7'-0"	4"	18'9"	NSM70F23-***	\$20,561	\$23,147
80'	12"	.375"	3	8'-0"	4"	18'9"	NSM80H23-***	\$25,794	\$28,677

*** - Finish Options

SAT = Satin
 BZT = Powder Coat - BronzeTone
 BLK = Powder Coat - Black
 WHT = Powder Coat - White
 CLR = Powder Coat - Clear

Quantity Discounts

5+ = 5% 8+ = 10% 15+ = 12%
 *Flagpoles From All Flagpole Series May Be Combined To Achieve Quantity Discounts.



NAUTICAL SINGLE MAST SERIES - NSM OPTIONS

Cast Aluminum, SEALED Bearings, Gold Powder Coated Ball Truck
 Replaces Standard Truck and Ball Combination - See Page 65.



8" Diameter Ball/Truck Add \$164
 10" Diameter Ball/Truck Add \$220
 12" Diameter Ball/Truck Add \$395

Cast Aluminum FC-11 In Lieu of Spun Collar - See Page 81.



5"-7" Butt Diameters Add \$67
 8"-12" Butt Diameters Add \$201

Flagpole Lighting Options are available for all Nautical Single Mast Series - NSM Flagpoles - See Pages 84-91.

Shoe Base Designs for Surface Mount Installations are available with all Nautical Single Mast Series - NSM Flagpoles. See Page 14.

5" Butt Diameters Add \$246
 6"-8" Butt Diameters Add \$304
 10" Butt Diameters Add \$608
 12" Butt Diameters Add \$1,209

Nautical Flagpoles are made to order, lead times vary.

Gaff Options Available.
 Contact Concord American Flagpole Customer Service for sizes, specifications and pricing.



Nautical Double Mast Series - NDM

External Double Revolving with Yardarm and Gaff - Rope Halyard

The Nautical Double Mast Series from Concord American Flagpole uses high strength aluminum brackets to produce an offset, double shaft nautical design. Available in heights from 30' to 80', these flagpoles include both the yardarm and gaff, authenticating the look of the mast and rigging design from historic sailing vessels.

STANDARD FLAGPOLE ACCESSORIES - 6" TO 8" BUTT DIAMETERS

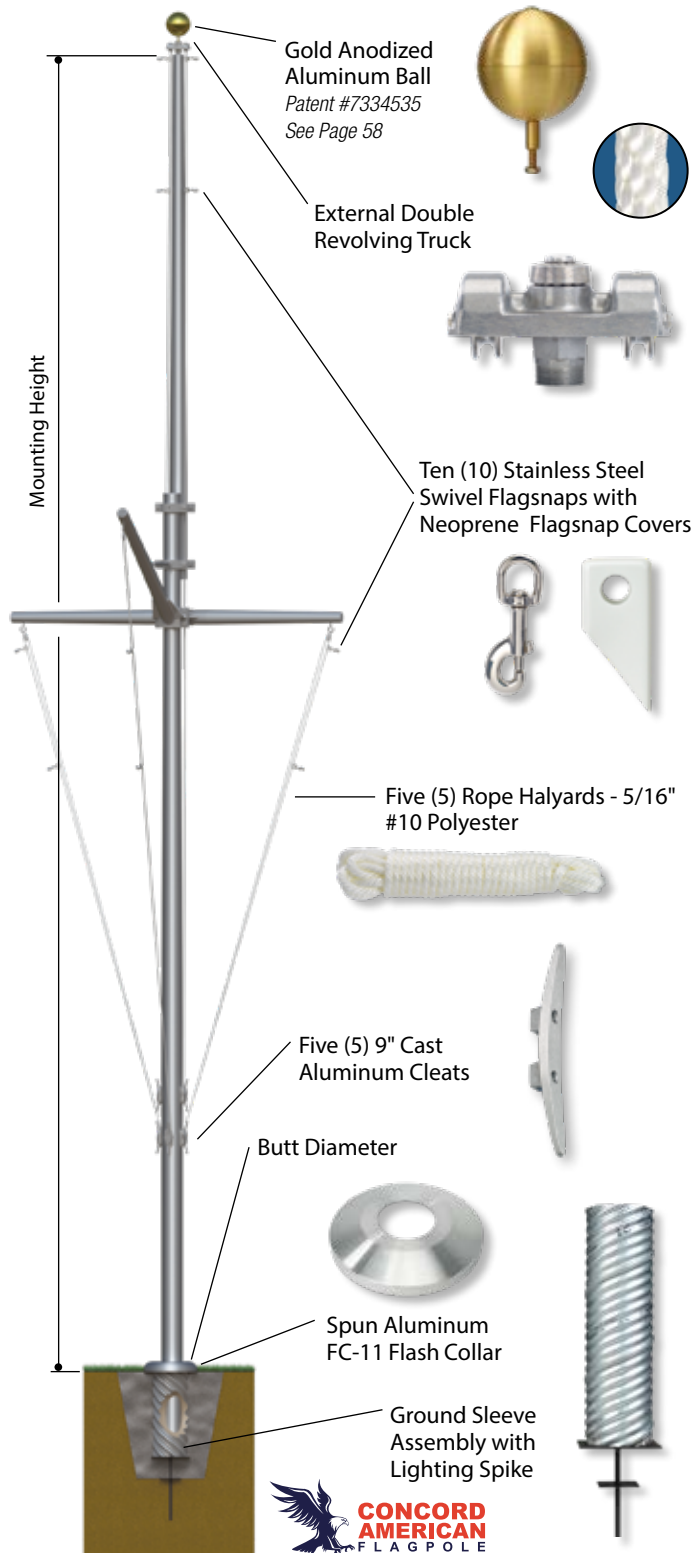

Standard Specifications

- Patented, Heavy-Duty Gold Anodized Aluminum Ball
- Cast Aluminum Double Revolving Truck Assembly with Aluminum Pulleys
- Extruded Aluminum Flagpole Bands with Stainless Steel Attaching Hardware
- Three (3) Eye Hook mounted Single Pulleys (*Yardarm and Gaff*)
- Complete External Halyard Assembly
 - Five (5) Rope Halyards - 5/16" #10 Polyester
 - Ten (10) Stainless Steel Swivel Flagnaps
 - Ten (10) Neoprene Flagnap Covers
- Five (5) 9" Heavy-Duty Aluminum Cleats
- Spun Aluminum FC-11 Flash Collar
- Galvanized 16-Gauge Corrugated Steel Ground Sleeve with Steel Grounding Spike

Standard Upgrades - 10" and 12" Butt Diameters

- Heavy-Duty Truck with Dual SEALED Bearing Assemblies
- Five (5) Rope Halyards - Heavy-Duty 3/8" #12 Polyester
- Ten (10) Heavy-Duty Stainless Steel Flagnaps with Covers
- Heavy-Duty 5/8" Ball Stem
- Heavy-Duty Cast Aluminum Collar

Nautical Double Mast Series - NDM External Double Revolving with Yardarm and Gaff - Rope Halyard

MTG HGT.	BUTT DIA.	WALL THICKNESS	POLE SECTIONS	SET DEPTH	TOP DIAM.	YARDARM LENGTH	GAFF LENGTH	CATALOG NUMBER ***SPECIFY FINISH	Satin	BRONZETONE, BLACK, WHITE, OR CLEAR POWDERCOAT
30'	6"	.188"	1	3'0"	3.5"	8'0"	5'0"	NDM30D61-***	\$8,788	\$9,482
	6"	.188"	2	3'0"	3.5"	8'0"	5'0"	NDM30D62-***	\$9,650	\$10,344
35'	7"	.188"	1	3'6"	3.5"	9'6"	6'0"	NDM35D71-***	\$10,271	\$11,205
	7"	.188"	2	3'6"	3.5"	9'6"	6'0"	NDM35D72-***	\$11,304	\$12,238
40'	8"	.188"	1	4'0"	4"	10'9"	7'0"	NDM40D81-***	\$12,459	\$13,662
	8"	.188"	2	4'0"	4"	10'9"	7'0"	NDM40D82-***	\$13,837	\$15,040
50'	10"	.188"	3	5'0"	4"	13'6"	9'0"	NDM50D13-***	\$17,921	\$19,772
60'	12"	.250"	3	6'0"	4"	16'0"	10'9"	NDM60F23-***	\$27,502	\$30,007
80'	12"	.375"	3	8'0"	4"	18'9"	12'9"	NDM80H23-***	\$39,818	\$43,045

*** - Finish Options

- SAT = Satin
- BZT = Powder Coat - BronzeTone
- BLK = Powder Coat - Black
- WHT = Powder Coat - White
- CLR = Powder Coat - Clear

Quantity Discounts

- 5+ = 5% 8+ = 10% 15+ = 12%
- *Flagpoles From All Flagpole Series May Be Combined To Achieve Quantity Discounts.

Nautical Flagpoles are made to order, lead times vary.

NAUTICAL DOUBLE MAST SERIES - NDM OPTIONS



Cast Aluminum FC-11
In Lieu of Spun Collar -
See Page 81.

- 6"-7" Butt Diameters Add \$67
- 8"-12" Butt Diameters Add \$201

Shoe Base Designs for Surface Mount Installations are available with all Nautical Double Mast Series – NDM Flagpoles. See Page 14.

- 6"-8" Butt Diameters Add \$304
- 10" Butt Diameters Add \$608
- 12" Butt Diameters Add \$1,209



Nautical Flagpoles are distinctive in their style, providing a "full sail" appearance perfect for projects requiring nautical themes, multiple flags or when restrictive sign ordinances can limit messaging opportunities.

Outrigger Wall Mount Series

External Single Stationary - Rope Halyard

The Outrigger Single Stationary Series from Concord American Flagpole offers wall mounted flagpole options in lengths of 6' to 20'. A variety of Wall Mount design and angle options give project owners the ability to enhance any building facade with the customized look and beauty of aluminum flagpoles.



STANDARD FLAGPOLE ACCESSORIES

Specifications

- Patented, Heavy-Duty Gold Anodized Aluminum Ball
- Cast Aluminum Single Stationary Truck Assembly with Aluminum Pulley
- Complete External Halyard Assembly
 - Rope Halyard - 5/16" #10 Polyester
 - Two (2) Solid Brass Swivel Flagsnaps
 - Two (2) Neoprene Flagsnap Covers
- 9" Cast Aluminum Cleat
- 3/8" Eyebolt and Double Swivel Pulley
- Anchorage by Others



O-30
45° Arm Angle
4 Bolt Design



O-31
30°, 45°, 60°
Arm Angle
3 Bolt Design



O-32
45° Arm Angle
4 Bolt Design



Gold Anodized Aluminum Ball
Patent #7334535
See Page 58

External Stationary Truck

Two (2) Solid Brass Swivel Flagsnaps with Neoprene Flagsnap Covers

Rope Halyard - 5/16" #10 Polyester

Double Swivel Pulley with Eyebolt

9" Cast Aluminum Cleat

Flagpole Lighting Options are available for all Outrigger Series Flagpoles - See Pages 84-88.

OUTRIGGER SERIES OPTIONS

Cap Mounted Style Single Revolving Truck In Lieu Of Standard Stationary Truck.



See Page 64 Add \$67

Outrigger Retainer System. Pulley Shown. See Page 83 for full System details.



Outrigger Retainer System Add \$74

Cleat Cover (Specify Cylinder Lock or Padlock) - See Page 77.



Cleat Cover.... Add \$178

Wall Anchorage Kit. Contains one Sleeve, one Bolt, Washers and Nuts. Offered as component pieces only for O-31 and O-32. See NOTE on page 83.



WAK-9421..... Add \$75 / Ea.



Outrigger Wall Mount Series External Single Stationary - Rope Halyard

O-30 - 45°

DESCRIPTION	NOMINAL OVERALL LENGTH	BUTT DIA.	WALL THICKNESS	POLE SECTIONS	TOP DIAM.	CATALOG NUMBER ***SPECIFY FINISH	Satin	CLEAR ANODIZED	DARK BRONZE OR BLACK ANODIZED	BRONZE TONE, BLACK, WHITE, OR CLEAR POWDERCOAT
O-30 - 45° Arm Angle - Straight Shaft	8'	3"	.125"	1	3"	O30-08B34-***	\$678	\$810	\$828	\$746
O-30 - 45° Arm Angle - Straight Shaft	10'	3"	.125"	1	3"	O30-10B34-***	\$810	\$969	\$991	\$895

O-31 - 30° / 45° / 60°

DESCRIPTION	NOMINAL OVERALL LENGTH	BUTT DIA.	WALL THICKNESS	POLE SECTIONS	TOP DIAM.	CATALOG NUMBER ***SPECIFY FINISH	Satin	CLEAR ANODIZED	DARK BRONZE OR BLACK ANODIZED	BRONZE TONE, BLACK, WHITE, OR CLEAR POWDERCOAT
O-31 - 30° Arm Angle - Tapered Shaft	6'	4"	.125"	1	3"	O31-06B43-***	\$1,861	\$2,182	\$2,199	\$1,916
O-31 - 30° Arm Angle - Tapered Shaft	8'	4"	.125"	1	3"	O31-08B43-***	\$1,908	\$2,244	\$2,267	\$1,981
O-31 - 30° Arm Angle - Tapered Shaft	10'	4"	.125"	1	3"	O31-10B43-***	\$1,997	\$2,355	\$2,383	\$2,088
O-31 - 30° Arm Angle - Tapered Shaft	12'	4"	.156"	1	3"	O31-12C43-***	\$2,094	\$2,475	\$2,509	\$2,203
O-31 - 30° Arm Angle - Tapered Shaft	15'	4"	.188"	1	3"	O31-15D43-***	\$2,187	\$2,594	\$2,637	\$2,323
O-31 - 30° Arm Angle - Tapered Shaft	18'	4"	.188"	1	3"	O31-18D43-***	\$2,721	\$3,225	\$3,276	\$2,884
O-31 - 30° Arm Angle - Tapered Shaft	20'	4"	.188"	1	3"	O31-20D43-***	\$2,931	\$3,476	\$3,533	\$3,112
O-31 - 45° Arm Angle - Tapered Shaft	6'	4"	.125"	1	3"	O31-06B44-***	\$1,861	\$2,182	\$2,199	\$1,916
O-31 - 45° Arm Angle - Tapered Shaft	8'	4"	.125"	1	3"	O31-08B44-***	\$1,908	\$2,244	\$2,267	\$1,981
O-31 - 45° Arm Angle - Tapered Shaft	10'	4"	.125"	1	3"	O31-10B44-***	\$1,997	\$2,355	\$2,383	\$2,088
O-31 - 45° Arm Angle - Tapered Shaft	12'	4"	.156"	1	3"	O31-12C44-***	\$2,094	\$2,475	\$2,509	\$2,203
O-31 - 45° Arm Angle - Tapered Shaft	15'	4"	.188"	1	3"	O31-15D44-***	\$2,187	\$2,594	\$2,637	\$2,323
O-31 - 45° Arm Angle - Tapered Shaft	18'	4"	.188"	1	3"	O31-18D44-***	\$2,721	\$3,225	\$3,276	\$2,884
O-31 - 45° Arm Angle - Tapered Shaft	20'	4"	.188"	1	3"	O31-20D44-***	\$2,931	\$3,476	\$3,533	\$3,112
O-31 - 60° Arm Angle - Tapered Shaft	6'	4"	.125"	1	3"	O31-06B46-***	\$1,861	\$2,182	\$2,199	\$1,916
O-31 - 60° Arm Angle - Tapered Shaft	8'	4"	.125"	1	3"	O31-08B46-***	\$1,908	\$2,244	\$2,267	\$1,981
O-31 - 60° Arm Angle - Tapered Shaft	10'	4"	.125"	1	3"	O31-10B46-***	\$1,997	\$2,355	\$2,383	\$2,088
O-31 - 60° Arm Angle - Tapered Shaft	12'	4"	.156"	1	3"	O31-12C46-***	\$2,094	\$2,475	\$2,509	\$2,203
O-31 - 60° Arm Angle - Tapered Shaft	15'	4"	.188"	1	3"	O31-15D46-***	\$2,187	\$2,594	\$2,637	\$2,323
O-31 - 60° Arm Angle - Tapered Shaft	18'	4"	.188"	1	3"	O31-18D46-***	\$2,721	\$3,225	\$3,276	\$2,884
O-31 - 60° Arm Angle - Tapered Shaft	20'	4"	.188"	1	3"	O31-20D46-***	\$2,931	\$3,476	\$3,533	\$3,112

O-32 - 45°

DESCRIPTION	NOMINAL OVERALL LENGTH	BUTT DIA.	WALL THICKNESS	POLE SECTIONS	TOP DIAM.	CATALOG NUMBER ***SPECIFY FINISH	Satin	CLEAR ANODIZED	DARK BRONZE OR BLACK ANODIZED	BRONZE TONE, BLACK, WHITE, OR CLEAR POWDERCOAT
O-32 - 45° Arm Angle - Tapered Shaft	6'	4"	.125"	1	3"	O32-06B44-***	\$2,349	\$2,748	\$2,765	\$2,404
O-32 - 45° Arm Angle - Tapered Shaft	8'	4"	.125"	1	3"	O32-08B44-***	\$2,491	\$2,920	\$2,943	\$2,564
O-32 - 45° Arm Angle - Tapered Shaft	10'	4"	.125"	1	3"	O32-10B44-***	\$2,662	\$3,126	\$3,155	\$2,753
O-32 - 45° Arm Angle - Tapered Shaft	12'	4"	.156"	1	3"	O32-12C44-***	\$2,803	\$3,297	\$3,332	\$2,912
O-32 - 45° Arm Angle - Tapered Shaft	15'	4"	.188"	1	3"	O32-15D44-***	\$3,208	\$3,778	\$3,821	\$3,344
O-32 - 45° Arm Angle - Tapered Shaft	18'	4"	.188"	1	3"	O32-18D44-***	\$3,350	\$3,954	\$4,006	\$3,513
O-32 - 45° Arm Angle - Tapered Shaft	20'	4"	.188"	1	3"	O32-20D44-***	\$3,465	\$4,095	\$4,153	\$3,646

*** - Finish Options

SAT = Satin

ACL = Anodized - Clear

ADB = Anodized - Dark Bronze

ABL = Anodized - Black

BZT = Powder Coat - Bronze Tone

BLK = Powder Coat - Black

WHT = Powder Coat - White

CLR = Powder Coat - Clear

Quantity Discounts

5+ = 5% 8+ = 10% 15+ = 12%

*Flagpoles From All Flagpole Series May Be Combined To Achieve Quantity Discounts.

NOTE: Cast Brackets Must Be Powder Coated. Due to the color variances between Anodized & Powder Coat finishes, it is recommended that Vertical Wall Mount Flagpoles be Powder Coated.

Vertical Wall Mount Series

External Single Revolving and Single Stationary - Rope Halyard

The Vertical Wall Mount Series from Concord American Flagpole provides commercial-grade, one and two-piece solid aluminum Wall Mount designs in 3" to 6" butt diameters in standard heights of 12' to 38.5'. Flagpole heights listed are maximum heights for each shaft listed. All shafts can be modified to shorter heights upon request.

STANDARD FLAGPOLE ACCESSORIES - 3" TO 6" BUTT DIAMETERS



VW-1
4 Bolt Design



VW-2
3 Bolt Design



VW-3
4 Bolt Design



VW-8
3 Bolt Design



VW-9
4 Bolt Design

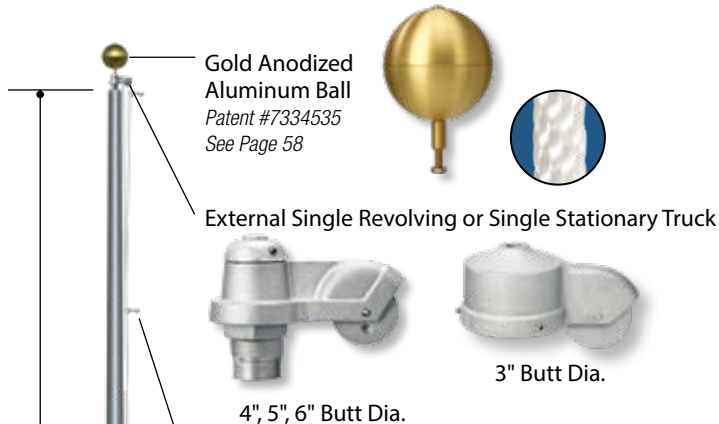

Mounting Height

Specifications

- Patented, Heavy-Duty Gold Anodized Aluminum Ball
- Cast Aluminum Single Revolving (4", 5", and 6" Butt Dia.) or Single Stationary (3" Butt Dia.) Truck Assembly with Aluminum Pulley.
- Complete External Halyard Assembly
 - Rope Halyard - 5/16" #10 Polyester
 - Two (2) Solid Brass Swivel Snap Hooks
 - Two (2) Neoprene Snap Hook Covers
- 9" Cast Aluminum Cleat
- Anchorage by Others

VERTICAL WALL MOUNT SERIES OPTIONS

Cast Aluminum, SEALED Bearings, Gold Powder Painted Ball Truck. Replaces Standard Truck and Ball Combination - See Page 65.



8" Diameter Ball/Truck .. Add \$164
10" Diameter Ball/Truck . Add \$220

Double Revolving System (Double Truck, Extra Cleat and Complete Double Halyard Assembly) - Specify EDR (External Double Revolving). See Page 63... Add \$67



Cleat Cover (Specify Cylinder Lock or Padlock) - See Page 77.



Cleat Cover... Add \$172

Wall Anchorage Kit. Contains one Sleeve, one Bolt, Washers and Nuts. Offered as component pieces only. See NOTE on page 83.



WAK-9421..... Add \$75 / Ea.

Flagpole Lighting Options are available for all Vertical Wall Mount Series Flagpoles - See Pages 84-88.



9" Cast Aluminum Cleat

NOTE: Cast Brackets Must Be Powder Coated. Due to the color variances between Anodized & Powder Coat finishes, it is recommended that Vertical Wall Mount Flagpoles be Powder Coated.

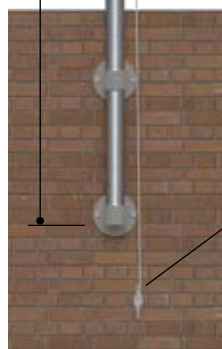

Vertical Wall Mount Series External Single Revolving and Single Stationary - Rope Halyard

VSS-1 Stationary

DESCRIPTION	NOMINAL OVERALL LENGTH	BUTT DIA.	WALL THICKNESS	POLE SECTIONS	TOP DIAM.	CATALOG NUMBER ***SPECIFY FINISH	Satin	CLEAR ANODIZED	DARK BRONZE OR BLACK ANODIZED	BRONZE TONE, BLACK, WHITE, OR CLEAR POWDERCOAT
VSS-1 - Straight Shaft - Stationary	12'	3"	.125"	1	3"	VSS1-12B31-***	\$758	\$914	\$941	\$860
	15'	3"	.125"	1	3"	VSS1-15B31-***	\$802	\$974	\$1,007	\$930

VTR-1 Revolving / VTS-1 Stationary

DESCRIPTION	NOMINAL OVERALL LENGTH	BUTT DIA.	WALL THICKNESS	POLE SECTIONS	TOP DIAM.	CATALOG NUMBER ***SPECIFY FINISH	Satin	CLEAR ANODIZED	DARK BRONZE OR BLACK ANODIZED	BRONZE TONE, BLACK, WHITE, OR CLEAR POWDERCOAT
VTS-1 - Tapered Shaft - Stationary	12'	3"	.125"	1	2"	VTS1-12B31-***	\$914	\$1,095	\$1,122	\$1,016
	15'	3"	.125"	1	2"	VTS1-15B31-***	\$1,095	\$1,314	\$1,347	\$1,223
	20'	3"	.125"	1	2"	VTS1-20B31-***	\$1,250	\$1,508	\$1,552	\$1,420
	25'	3"	.125"	1	2"	VTS1-25B31-***	\$1,431	\$1,732	\$1,787	\$1,643
VTR-1 - Tapered Shaft - Revolving	15'	4"	.125"	1	3"	VTR1-15B41-***	\$2,180	\$2,586	\$2,629	\$2,316
	20'	4"	.125"	1	3"	VTR1-20B41-***	\$2,328	\$2,776	\$2,834	\$2,509
	25'	5"	.156"	1	3"	VTR1-25C51-***	\$3,186	\$3,815	\$3,904	\$3,508
	30'	6"	.156"	1	3.5"	VTR1-30C61-***	\$3,955	\$4,760	\$4,888	\$4,408
	30'	6"	.188"	1	3.5"	VTR1-30D61-***	\$4,235	\$5,085	\$5,212	\$4,688
	35'	6"	.188"	1	3.5"	VTR1-35D61-***	\$4,942	\$5,934	\$6,082	\$5,470

VTR-2 Revolving

DESCRIPTION	NOMINAL OVERALL LENGTH	BUTT DIA.	WALL THICKNESS	POLE SECTIONS	TOP DIAM.	CATALOG NUMBER ***SPECIFY FINISH	Satin	CLEAR ANODIZED	DARK BRONZE OR BLACK ANODIZED	BRONZE TONE, BLACK, WHITE, OR CLEAR POWDERCOAT
VTR-2 - Tapered Shaft - Revolving	15'	4"	.125"	1	3"	VTR2-15B41-***	\$2,575	\$3,044	\$3,087	\$2,711
	20'	4"	.125"	1	3"	VTR2-20B41-***	\$2,978	\$3,530	\$3,588	\$3,159
	25'	5"	.156"	1	3"	VTR2-25C51-***	\$3,977	\$4,732	\$4,822	\$4,299
	30'	6"	.156"	1	3.5"	VTR2-30C61-***	\$4,977	\$5,946	\$6,073	\$5,430
	30'	6"	.188"	1	3.5"	VTR2-30D61-***	\$5,722	\$6,810	\$6,937	\$6,175
	35'	6"	.188"	1	3.5"	VTR2-35D61-***	\$6,722	\$7,999	\$8,147	\$7,250

VTR-3 Revolving

DESCRIPTION	NOMINAL OVERALL LENGTH	BUTT DIA.	WALL THICKNESS	POLE SECTIONS	TOP DIAM.	CATALOG NUMBER ***SPECIFY FINISH	Satin	CLEAR ANODIZED	DARK BRONZE OR BLACK ANODIZED	BRONZE TONE, BLACK, WHITE, OR CLEAR POWDERCOAT
VTR-3 - Tapered Shaft - Revolving	15'	4"	.125"	1	3"	VTR3-15B41-***	\$2,180	\$2,586	\$2,629	\$2,316
	20'	4"	.125"	1	3"	VTR3-20B41-***	\$2,328	\$2,776	\$2,834	\$2,509
	25'	5"	.156"	1	3"	VTR3-25C51-***	\$3,186	\$3,815	\$3,904	\$3,508
	30'	6"	.156"	1	3.5"	VTR3-30C61-***	\$3,955	\$4,760	\$4,888	\$4,408
	30'	6"	.188"	1	3.5"	VTR3-30D61-***	\$4,235	\$5,085	\$5,212	\$4,688
	35'	6"	.188"	1	3.5"	VTR3-35D61-***	\$4,491	\$5,411	\$5,559	\$5,019

VTR-8 Revolving

DESCRIPTION	NOMINAL OVERALL LENGTH	BUTT DIA.	WALL THICKNESS	POLE SECTIONS	TOP DIAM.	CATALOG NUMBER ***SPECIFY FINISH	Satin	CLEAR ANODIZED	DARK BRONZE OR BLACK ANODIZED	BRONZE TONE, BLACK, WHITE, OR CLEAR POWDERCOAT
VTR-8 - Tapered Shaft - Revolving	15'	4"	.125"	1	3"	VTR8-15B41-***	\$4,440	\$5,207	\$5,250	\$4,576
	20'	4"	.125"	1	3"	VTR8-20B41-***	\$5,001	\$5,877	\$5,934	\$5,182
	25'	5"	.156"	1	3"	VTR8-25C51-***	\$6,210	\$7,322	\$7,412	\$6,532
	30'	6"	.156"	1	3.5"	VTR8-30C61-***	\$6,558	\$7,780	\$7,907	\$7,011
	30'	6"	.188"	1	3.5"	VTR8-30D61-***	\$7,606	\$8,995	\$9,123	\$8,059
	35'	6"	.188"	1	3.5"	VTR8-35D61-***	\$8,350	\$9,887	\$10,036	\$8,878

VTR-9 Revolving

DESCRIPTION	NOMINAL OVERALL LENGTH	BUTT DIA.	WALL THICKNESS	POLE SECTIONS	TOP DIAM.	CATALOG NUMBER ***SPECIFY FINISH	Satin	CLEAR ANODIZED	DARK BRONZE OR BLACK ANODIZED	BRONZE TONE, BLACK, WHITE, OR CLEAR POWDERCOAT
VTR-9 Tapered Shaft - Revolving	15'	4"	.125"	1	3"	VTR9-15B41-***	\$4,693	\$5,501	\$5,544	\$4,829
	20'	4"	.125"	1	3"	VTR9-20B41-***	\$5,233	\$6,146	\$6,203	\$5,414
	25'	5"	.156"	1	3"	VTR9-25C51-***	\$6,466	\$7,619	\$7,709	\$6,788
	30'	6"	.156"	1	3.5"	VTR9-30C61-***	\$6,816	\$8,079	\$8,206	\$7,269
	30'	6"	.188"	1	3.5"	VTR9-30D61-***	\$7,862	\$9,292	\$9,420	\$8,315
	35'	6"	.188"	1	3.5"	VTR9-35D61-***	\$8,606	\$10,184	\$10,333	\$9,134

*** - Finish Options
 SAT = Satin
 ACL = Anodized - Clear

ADB = Anodized - Dark Bronze
 ABL = Anodized - Black
 BZT = Powder Coat - Bronze Tone

BLK = Powder Coat - Black
 WHT = Powder Coat - White
 CLR = Powder Coat - Clear

Quantity Discounts 5+ = 5% 8+ = 10% 15+ = 12%
 *Flagpoles From All Flagpole Series May Be Combined To Achieve Quantity Discounts.



Internal Vertical Wall Mount Series - VIC

Internal Cam Cleat - Rope Halyard

The Internal Halyard Vertical Wall Mount Series brings the security of Concord American Flagpole's Sentry Series to a Vertical Wall Mount, Cam Cleat design. This design provides a more aesthetic appearance to the installed flagpole by replacing the external Rope Halyard and Cleat associated with standard external Wall Mount installations.

STANDARD FLAGPOLE ACCESSORIES - 5" BUTT DIAMETERS

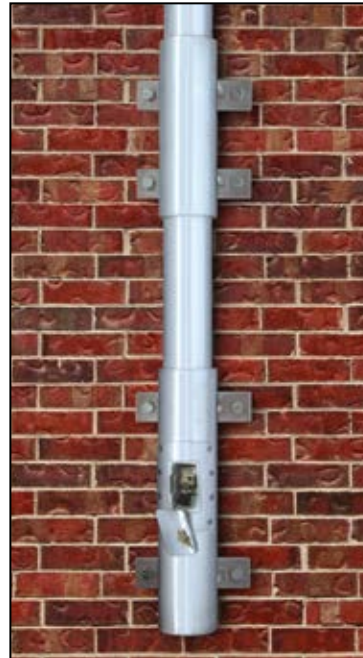
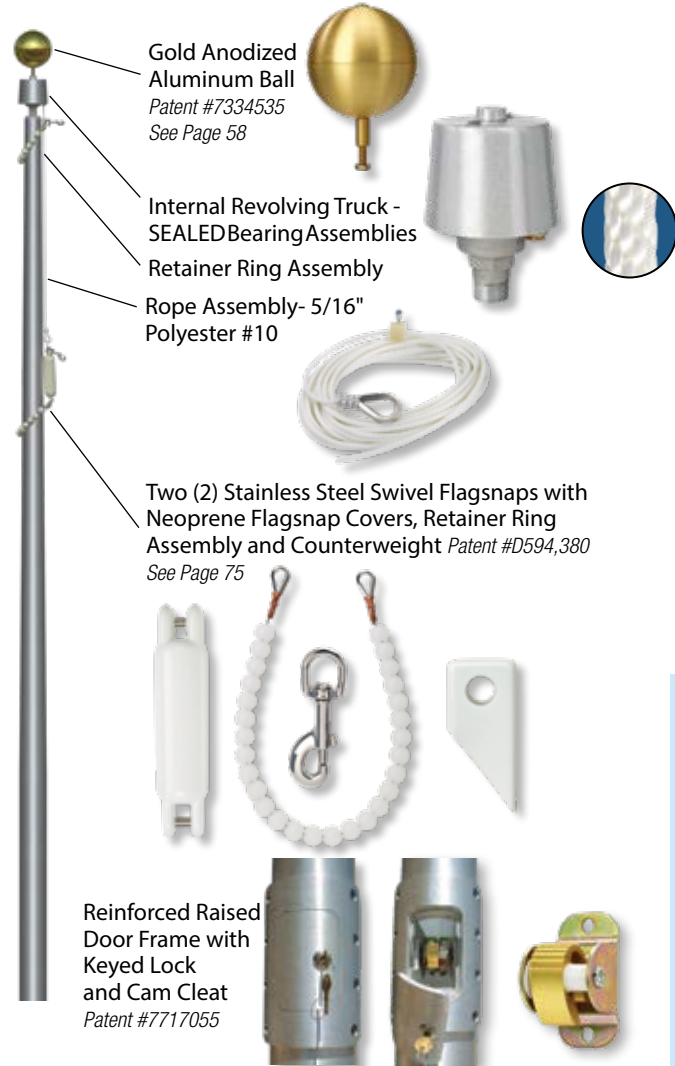

Specifications -

- 5" Butt Diameters
 - Patented, Heavy-Duty Gold Anodized Aluminum Ball
 - Cast Aluminum Revolving Truck with SEALED Stainless Steel Bearing Assemblies, Aluminum Spindle, Cast Brass Exit Bushing and Removable Hood
 - Complete Internal Halyard Assembly
 - Rope Halyard - 5/16" #10 Polyester
 - Flag Arrangement (8' x 12' Flags and Above with Heavy-Duty Shock Spring Assembly)
 - Two (2) Stainless Steel Swivel Flagsnaps with Neoprene Flagsnap Covers
 - Patented, Plastic Coated Counterweight
 - Two (2) Beaded Retainer Ring Assemblies
 - Cam Cleat
 - Reinforced Rased Door Frame
 - Flush Mount Access Door with Lock and Keys
- VIC Options
Ball Truck (See Page 68) and Flagpole Lighting Options (See Pages 84-88).

The Internal Vertical Wall Mount Cam Cleat Series mounts the Cam Cleat assembly in the lower bracket rather than in the flagpole shaft, allowing for easy access to the Internal Rope Halyard System.

The flagpole shaft slides through the upper bracket and into the lower bracket, resting upon an internally welded ring above the Cam Cleat assembly. Both the upper and lower aluminum bracket assemblies are designed with dual mounting plates that provide a total of 8 attachment bolts for maximum attachment strength. Set screws in both brackets secure the pole into place. The flagpole is equipped with the highest quality component parts matching those of our popular Sentry Series. A second Retainer Ring Assembly and Connecting Link for use at the top of the flag is included to assist in lowering the flag to the top of the upper bracket.

Internal Vertical Wall Mount Series - VIC Internal Cam Cleat - Rope Halyard

NOMINAL OVERALL HEIGHT	DESCRIPTION	BUTT DIA.	WALL THICKNESS	POLE SECTIONS	TOP DIAM.	CATALOG NUMBER ***SPECIFY FINISH	Satin	CLEAR ANODIZED	DARK BRONZE OR BLACK ANODIZED	BRONZE TONE, BLACK, WHITE, OR CLEAR POWDER COAT
20'	VIC Internal Halyard - Cam Cleat	5"	.188"	1	3"	VIC20D51-***	\$3,611	\$4,284	\$4,356	\$3,869
25'	VIC Internal Halyard - Cam Cleat	5"	.188"	1	3"	VIC25D51-***	\$4,051	\$4,818	\$4,908	\$4,373
30'	VIC Internal Halyard - Cam Cleat	5"	.188"	1	3"	VIC30D51-***	\$4,506	\$5,369	\$5,477	\$4,893

Quantity Discounts 5+ = 5% 8+ = 10% 15+ = 12%
*Flagpoles From All Flagpole Series May Be Combined To Achieve Quantity Discounts.

NOTE: Cast Brackets Must Be Powder Coated. Due to the color variances between Anodized & Powder Coat finishes, it is recommended that Vertical Wall Mount Flagpoles be Powder Coated.



Internal Vertical Wall Mount Series - VIW

Internal Winch - Wire Halyard

The Internal Halyard Vertical Wall Mount Winch Series incorporates Concord American Flagpole's Winch and Wire Cable System used in our Independence Series into a Vertical Wall Mount design. The security provided by this Winch system combines the perfect solution to vandalism with the clean lines and aesthetics obtained with an Internal Halyard flagpole.

STANDARD FLAGPOLE ACCESSORIES - 5" BUTT DIAMETERS

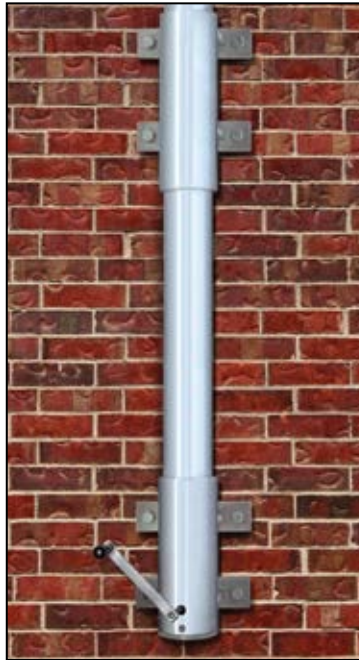
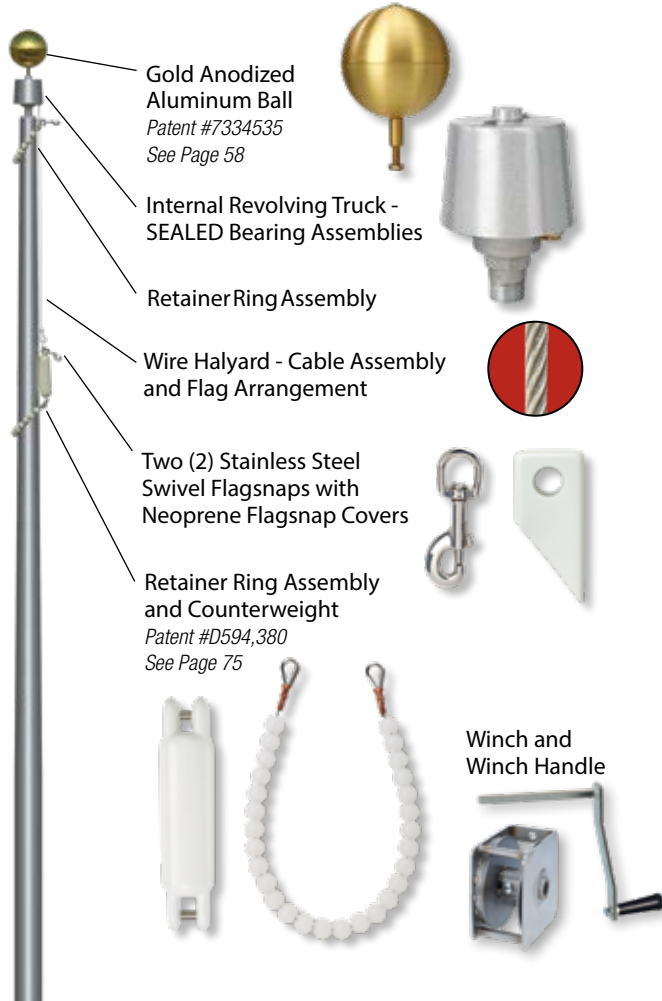

Specifications -

- 5" Butt Diameters
- Patented, Heavy-Duty Gold Anodized Aluminum Ball
- Cast Aluminum Revolving Truck with SEALED Stainless Steel Bearing Assemblies, Aluminum Spindle, Cast Brass Exit Bushing and Removable Hood
- Complete Internal Halyard Assembly
 - Wire Halyard Cable Assembly
 - Flag Arrangement (8' x 12' Flags and Above with Heavy-Duty Shock Spring Assembly)
 - Two (2) Stainless Steel Swivel Flagsnaps with Neoprene Flagsnap Covers
 - Patented, Plastic Coated Counterweight
 - Two (2) Beaded Retainer Ring Assemblies
- Stainless Steel Winch Assembly with Removable Hand Crank

VIW Options

Ball Truck (See Page 68) and Flagpole Lighting Options (See Pages 84-88).

The Internal Vertical Wall Mount Winch Series is designed with the Winch attached to a platform installed into the bottom of the lower bracket. The flagpole shaft slides through the upper bracket and into the lower bracket, resting upon an internally welded ring above the winch assembly. The Winch and platform can be removed for maintenance by removing the tamper-proof mounting screw. Both aluminum bracket assemblies are designed with dual mounting plates that provide a total of 8 attachment bolts for maximum attachment strength. Set screws secure the pole into place. The flagpole is equipped with the highest quality component parts matching those of our popular Independence Series. A second Retainer Ring Assembly and Connecting Link for use at the top of the flag is included to assist in lowering the flag to the top of the upper bracket.

Internal Vertical Wall Mount Series - VIW Internal Winch - Wire Halyard

NOMINAL OVERALL HEIGHT	DESCRIPTION	BUTT DIA.	WALL THICKNESS	POLE SECTIONS	TOP DIAM.	CATALOG NUMBER ***SPECIFY FINISH	Satin	CLEAR ANODIZED	DARK BRONZE OR BLACK ANODIZED	BRONZE TONE, BLACK, WHITE, OR CLEAR POWDER COAT
20'	VIW Internal Halyard - Winch	5"	.188"	1	3"	VIW20D51-***	\$4,653	\$5,493	\$5,565	\$4,911
25'	VIW Internal Halyard - Winch	5"	.188"	1	3"	VIW25D51-***	\$4,972	\$5,886	\$5,976	\$5,294
30'	VIW Internal Halyard - Winch	5"	.188"	1	3"	VIW30D51-***	\$5,575	\$6,609	\$6,717	\$5,962

Quantity Discounts 5+ = 5% 8+ = 10% 15+ = 12%
*Flagpoles From All Flagpole Series May Be Combined To Achieve Quantity Discounts.

NOTE: Cast Brackets Must Be Powder Coated. Due to the color variances between Anodized & Powder Coat finishes, it is recommended that Vertical Wall Mount Flagpoles be Powder Coated.



American Tradition Flagpole Kit

Residential Tapered Aluminum Flagpole Kit

The American Tradition Flagpole Kit is the industry's premiere Flagpole Kit. Manufactured in our facility to exact specifications, this kit contains all of the Concord American Flagpole quality seen in our standard offering, providing the highest-quality, longest-lasting flagpole kit in the industry.

- **6063 Aluminum Alloy**
Seamless, COMMERCIAL-GRADE aluminum alloy.
- **Tapered Sections**
Cone Tapered sections are manufactured to precise tolerances for easy and attractive installations.
- **Satin Aluminum Finish**
A natural aluminum finish that will never rust.
- **Heavy-Duty Components**
The same standard components used on our Estate ESS commercial series flagpoles.
- **Shipped Complete with all Accessories and Ground Sleeve**
All components necessary for a long lasting, permanent installation. *(Flags sold separately - see Pages 56-57).*
- **FED EX and UPS Shippable**



The American Tradition's sturdy .125" Aluminum Wall Construction delivers superior strength and longevity in an easy-to-assemble kit.



American Tradition Flagpole Kit

NOMINAL OVERALL HEIGHT	DESCRIPTION	BUTT DIA.	WALL THICKNESS	POLE SECTIONS	TOP DIAM.	CATALOG NUMBER ***SPECIFY FINISH	SATIN	ANODIZED CLEAR	ANODIZED BRONZE & BLACK	POWDER COAT
20'	American Tradition Flagpole Kit	3"	0.125"	3	2"	ATK20B33-***	\$750	\$880	\$960	\$1,000
25'	American Tradition Flagpole Kit	3"	0.125"	4	2"	ATK25B34-***	\$880	\$1,020	\$1,100	\$1,200

Quantity Discounts 10+ Deduct 10%, **Additional discounts available for full pallets**
Contact Customer Service for more info

*** - Specify Finish
 SAT = Satin
 ACL = Anodized Clear
 BZT = Bronze Tone Powder Coat
 BLK = Black Powder Coat
 WHT = White Powder Coat
 ADB = Anodized Dark Bronze
 ABL = Anodized Black



Standard Features

- 20' and 25' Mounting Heights
- Full 3" Butt Diameter
- 3" Gold Anodized Ball Ornament
- Cast Aluminum Single Stationary Truck Assembly with Nylon Pulley
- Complete External Halyard Assembly
 - Rope Halyard - #10 Polyester
 - Two (2) Chrome Plated Bronze Snap Hooks
- 6" Cleat with Attaching Screws
- PVC Foundation Sleeve

Options

- Cap Style Revolving Truck Assembly *(See Page 64)*...Add \$52
- Spun Aluminum Collar *(See Page 80)*...Add \$45





DOCK & DECK MOUNT

Designed especially for the American Elite Telescoping 20' and 25'

- Base flange is 8"x8" with a 12" tall sleeve
- Mounting holes accommodate up to 3/4" bolts (hardware NOT included)

Add...\$200



American Elite Telescoping Flagpole

Heavy-Duty Shaft with "Easy Lock" Construction

The American Elite is the industry's highest quality telescoping flagpole. Designed with both residential and light commercial users in mind, the multiple design patents provide the industry's longest-lasting and easiest to install telescoping flagpole. Our unique "Easy Lock" system provides users the ability to quickly raise and lower the flagpole while the "Swivel Ring System" allows the flag to rotate freely.

Standard Features

- "Easy Lock" System (*Patented*) - Extends quickly and easily, securely locking each section in place, no arrows to line up or hair pins to push
- Split Ring Swivels constructed of Lexan polycarbonate with UV blockers - no hardware to bang against the pole or rope halyard to wear or tangle
- High Strength Aluminum Alloy 6000 Series with T6 Temper
- Clear Anodized Aluminum Finish
- Maintenance-Free
- Portable

Flagpole Kit Includes the Following:

- Telescoping Flagpole Shaft
- Swivel Rings With Flagsnaps to Fly One or Two Flags
- Additional Swivel Ring to Fly One Flag at Half Mast
- Ground Sleeve
- Gold Ball Finial
- 3' X 5' U.S. Nylon Flag, Double Stitched with Embroidered Stars



TAILGATER STADIUM SERIES MOUNTS

Hitch Mount

Designed especially for the American Elite Telescoping 20' and 25'

- Works with all standard 2" hitch receivers, includes pin
- Open design allows pole to rest against the ground for stability
- Perfect for tailgating, camping, or events

Add...\$160



Drive Over Mount

Designed especially for the American Elite Telescoping 20' and 25'

- 2-piece, slip-fit design allows for compact storage, easy set up, no tools required
- Roll your tire over base plate
- Perfect for tailgating, camping, or events

Add...\$200



Watch our How To Install the American Elite Telescoping Flagpole Video

American Elite Telescoping Flagpole

NOMINAL OVERALL HEIGHT	DESCRIPTION	BUTT DIA.	WALL THICKNESS	POLE SECTIONS	CATALOG NUMBER ***SPECIFY FINISH	CLEAR ANODIZED	ANODIZED BRONZE & BLACK OR WHITE & CLEAR POWDERCOAT	OAK WOODGRAIN
20'	American Elite Telescoping Flagpole	3"	0.080"	4	AET20T31-***	\$440	\$575	\$600
25'	American Elite Telescoping Flagpole	3"	0.080"	5	AET25T31-***	\$503	\$642	\$676

Quantity Discounts 10+ Deduct 10%. **Additional discounts available for full pallets**
Contact Customer Service for more info

American Elite Telescoping Flagpoles are FED EX and UPS Shippable

- *** - Specify Finish
 ACL = Anodized Clear
 ADB = Anodized Dark Bronze
 ABL = Anodized Black
 BZT = BronzeTone Powder Coat
 BLK = Black Powder Coat
 WHT = White Powder Coat
 OAK = Oak Woodgrain



American Spirit Kit

Residential Non-Tapered Aluminum Flagpole Kits

The lightweight yet strong American Spirit Series offers an excellent value in a beautiful, non-tapered modular flagpole that makes the perfect choice for the home or small business.

Standard Features

- 20' and 25' Mounting Heights
- 2" and 2.5" Butt Diameters
- 6063 Aluminum Alloy
- 3" Gold Anodized Ball Ornament
- Cast Aluminum Single Stationary Truck
- Polyester Rope Halyard
- Nylon Flagsnaps
- Plated Cleat
- PVC Foundation Sleeve
- Heavy-Wall Shipping and Storage Tube
- Fed Ex and UPS Shippable

Options

- Cap Style Revolving Truck Assembly (See Page 62)...Add \$52
- Never-Furl™ Assembly (2" Only - In lieu of truck, halyard, cleat and flagsnaps)...No Charge
- Spun Aluminum Collar (See Page 80)...Add \$48

*** - Specify Finish
 ACL = Anodized - Clear
 WHT = White



American Spirit Patio Flagpole Kits

MTG HEIGHT	DESCRIPTION	BUTT DIA.	WALL THICKNESS	SET DEPTH	POLE SECTIONS	TOP DIAM.	CATALOG NUMBER ***SPECIFY FINISH	CLEAR ANODIZED	WHITE POWDERCOAT
10'	American Spirit Non-Tapered Flagpole Kit	2"	0.0625"	1'-6"	2	2"	PAT10PB2-***	\$200	\$210
15'	American Spirit Non-Tapered Flagpole Kit	2"	0.0625"	1'-6"	3	2"	PAT15PB3-***	\$260	\$280
20'	American Spirit Non-Tapered Flagpole Kit	2"	0.0625"	1'-6"	4	2"	PAT20PB4-***	\$320	\$350
	American Spirit Non-Tapered Flagpole Kit	2.5"	0.0650"	2'-6"	5	2.5"	PAT20PD5-***	\$370	\$379
25'	American Spirit Non-Tapered Flagpole Kit	2.5"	0.0650"	2'-6"	6	2.5"	PAT25PD6-***	\$406	\$416

Quantity Discount: 5+ Deduct 5%. 10+ Deduct 10%. Quantities may be combined.

Never-Furl™ Assembly

American Spirit Flagpoles can also be fitted with the popular NeverFurl™ rotating system. The NeverFurl™ system replaces the truck assembly, cleat, halyard and flag snaps, providing a clean, quiet, and tangle-free flagpole system. The provided 3" Diameter Ball screws into a fitted plug that fits into the top of the flagpole to retain a finished flagpole appearance.

Never-Furl™ Assembly

The Never-Furl™ Assembly can be substituted in lieu of the truck, halyard cleat and flagsnaps on any American Spirit flagpole at NO CHARGE.

Never-Furl NFA-0200 (Sold Separately)...\$40



Part No. NFA-0200



Patio Wall Mount Kits
Outrigger and Vertical



Standard Features

- 6063 Aluminum Alloy
- 3" Gold Anodized Ball Ornament
- Cast Aluminum Single Stationary Truck
- Polyester Rope Halyard
- Nylon Flagsnaps
- Plated Cleat (OP-5 Only)
- Fed Ex and UPS Shippable

Options

- Cap Style Revolving Truck Assembly (See Page 64)...Add \$52
- Never-Furl™ Assembly - See Page 54 (2" Only - In lieu of truck, halyard, cleat and flagsnaps)...No Charge



*** - Specify Finish
ACL = Anodized - Clear
WHT = White

Patio Outrigger Wall Mount Flagpole Kit With One Cast Aluminum Bracket

MTG HEIGHT	DESCRIPTION	BUTT DIA.	WALL THICKNESS	POLE SECTIONS	TOP DIAM.	CATALOG NUMBER ***SPECIFY FINISH	CLEAR ANODIZED	WHITE POWDERCOAT
6'	OP-5 Bracket - 30° Arm Angle	2"	.0625"	1	2"	OP506PB3-***	\$187	\$212
12'	OP-5 Bracket - 30° Arm Angle	2"	.0625"	2	2"	OP512PB4-***	\$234	\$306
6'	OP-6 Bracket - 30° Arm Angle	2"	.0625"	1	2"	OP606PB3-***	\$230	\$240
6'	OP-6 Bracket - 45° Arm Angle	2"	.0625"	1	2"	OP606PB4-***	\$230	\$240

Quantity Discount: 5+ Deduct 5%. 10+ Deduct 10%. Quantities may be combined.
Brackets are Powder Coated.

Patio Vertical Wall Mount Flagpole Kit With Two Cast Aluminum Brackets

MTG HEIGHT	DESCRIPTION	BUTT DIA.	WALL THICKNESS	POLE SECTIONS	TOP DIAM.	CATALOG NUMBER ***SPECIFY FINISH	CLEAR ANODIZED	WHITE POWDERCOAT
6'	VP-1 Bracket - 90° Arm Angle - Straight Shaft	2"	.0625"	1	2"	VP106PB4-***	\$230	\$240
12'	VP-1 Bracket - 90° Arm Angle - Straight Shaft	2"	.0625"	2	2"	VP112PB4-***	\$293	\$312

Quantity Discount: 5+ Deduct 5%. 10+ Deduct 10%. Quantities may be combined.
Brackets are Powder Coated.



VP-1

Wall Mounts are compatible with the American Spirit Flagpole Kit





Nylon Flags

Our most popular flag, Nylon flags are produced from weather resistant premium nylon fabric chosen for maximum beauty and fly-ability.

- The perfect combination of strength, beauty and lightweight material allow nylon flags to fly in the slightest of breezes.
- UV protective technologies provide rich, vibrant colors that are protected from the sun's harmful rays.
- Precision embroidered White Stars (sewn Appliqué Stars on larger flag sizes).
- A combination of Chain stitching on horizontal seams and Lock stitching on all edge hems provide the longest lasting flag durability.

Polyester Flags

Polyester flags are produced from a premium, tear-resistant spun polyester fabric that provides maximum durability. The strong, yet lightweight, woven material combines maximum strength and fly-ability.

- 2-Ply construction provides extended flag life in the toughest of outdoor environments.
- Lock stitched reinforced seams.

Note: Flagpole Wind Speeds found in the Flagpole family tables are calculated with a Nylon flag and cannot be used when a Polyester flag is preferred. Refer to Pages 92-94 Flagpole Wind Speed for wind speed information when using Polyester Flags.

US Flags

Flags from Concord American Flagpole are manufactured from today's most advanced, highest quality materials utilizing advanced technologies and stitching techniques. All labor and materials are certified...

"100% Made in the USA".



NYLON					POLYESTER			
SIZE	DESCRIPTION	PART NUMBER	1+	6+	DESCRIPTION	PART NUMBER	1+	6+
2' x 3'	US Flag - Nylon	FLG-0203N-US	\$42	\$40	US Flag - Polyester - 2-Ply	-	-	-
3' x 5'		FLG-0305N-US	\$63	\$58		FLG-0305P-US	\$74	\$69
4' x 6'		FLG-0406N-US	\$77	\$74		FLG-0406P-US	\$109	\$100
5' x 8'		FLG-0508N-US	\$120	\$114		FLG-0508P-US	\$169	\$152
6' x 10'		FLG-0610N-US	\$170	\$162		FLG-0610P-US	\$264	\$246
8' x 12'		FLG-0812N-US	\$314	\$303		FLG-0812P-US	\$421	\$404
10' x 15'		FLG-1015N-US	\$481	\$460		FLG-1015P-US	\$632	\$615
12' x 18'		FLG-1218N-US	\$644	\$623		FLG-1218P-US	\$791	\$755
15' x 25'		FLG-1525N-US	\$1,111	\$1,088		FLG-1525P-US	\$1,404	\$1,352
20' x 30'		FLG-2030N-US	\$1,485	\$1,404		FLG-2030P-US	\$2,019	\$1,949
20' x 38'		FLG-2038N-US	\$1,746	\$1,668		FLG-2038P-US	\$2,387	\$2,300
30' x 50'		FLG-3050N-US	\$3,232	\$3,089		FLG-3050P-US	\$5,028	\$4,932
30' x 60'		FLG-3060N-US	\$3,842	\$3,685		FLG-3060P-US	\$5,248	\$5,089

Texas Flags –

Large Sizes

Constructed of the highest quality materials, these Large Size Texas Flags are offered in both Nylon and Polyester options in sizes to 30' x 60'. See Page 57 for standard size Texas flags.



NYLON				POLYESTER		
SIZE	PART NUMBER	1+	6+	PART NUMBER	1+	6+
6' x 10'	FLG-0610N-TX	\$177	\$174	FLG-0610-TX	\$260	\$255
8' x 12'	FLG-0812N-TX	\$300	\$293	FLG-0812P-TX	\$370	\$362
10' x 15'	FLG-1015N-TX	\$489	\$479	FLG-1015P-TX	\$580	\$569
12' x 18'	FLG-1218N-TX	\$664	\$651	FLG-1218P-TX	\$804	\$788
15' x 25'	FLG-1525N-TX	\$875	\$856	FLG-1525P-TX	\$1,120	\$1,099
20' x 30'	FLG-2030N-TX	\$1,488	\$1,460	FLG-2030P-TX	\$1,931	\$1,893
20' x 38'	FLG-2038N-TX	\$1,598	\$1,565	FLG-2038P-TX	\$2,142	\$2,098
30' x 60'	FLG-3060N-TX	\$3,073	\$3,011	FLG-3060P-TX	\$4,037	\$3,957

Military Flags

The official flags of our Nation's finest, these quality Nylon Military Flags are available for every branch of our US Military as well as a POW-MIA option.

Support Our Troops!

Military Flag Part Number Example:
FLG-0406N-USMC
4' X 6' Nylon Marine Corps Flag

Part Number (Branch) Options

- USAF = Air Force
- ARMY = Army
- USCG = Coast Guard
- USMC = Marine Corps
- NAVY = Navy

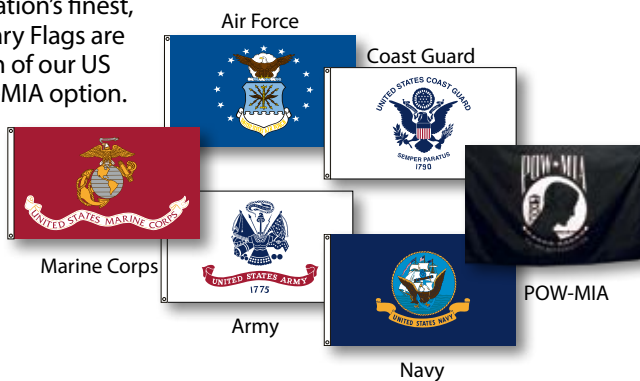

NYLON			
SIZE	PART NUMBER	1+	6+
Military Flag			
2' x 3'	FLG-0203N-(BRANCH)	\$66	\$64
3' x 5'	FLG-0305N-(BRANCH)	\$67	\$66
4' x 6'	FLG-0406N-(BRANCH)	\$151	\$148
5' x 8'	FLG-0508N-(BRANCH)	\$211	\$206
6' x 10'	FLG-0610N-(BRANCH)	\$487	\$477
POW Flag			
2' x 3'	FLG-0203N-POW	\$49	\$47
3' x 5'	FLG-0305N-POW	\$64	\$62
4' x 6'	FLG-0406N-POW	\$99	\$96
5' x 8'	FLG-0508N-POW	\$149	\$146
6' x 10'	FLG-0610N-POW	\$452	\$443

Christian Flag

Our Christian Flag is produced in a sewn Nylon construction.



NYLON			
SIZE	PART NUMBER	1+	6+
Christian Flag			
3' x 5'	FLG-0305N-CHR	\$109	\$106
4' x 6'	FLG-0406N-CHR	\$161	\$158
5' x 8'	FLG-0508N-CHR	\$234	\$229
6' x 10'	FLG-0610N-CHR	\$726	\$711



State Flags

Constructed of the highest quality fabric, our State Flags are unsurpassed in elegance and craftsmanship. Specifically engineered for outdoor use, the intricate flag design of each of our 50 States is reproduced to exacting specifications.

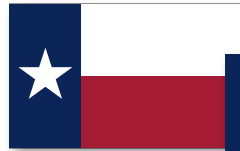

Texas (TX)



Virginia (VA)



Florida (FL)



Iowa (IA)

"100% Made in the USA"

NYLON PART # EXAMPLE*
FLG-0305N-AL

0305N
3' x 5'

0406N
4' x 6'

0508N
5' x 8'

0610N
6' x 10'

POLYESTER PART # EXAMPLE**
FLG-0305P-AL

0305P
3' x 5'

0406P
4' x 6'

0508P
5' x 8'

STATE FLAG	ABV	PART NUMBER	NYLON				POLYESTER				PART NUMBER	POLYESTER					
			1+	6+	1+	6+	1+	6+	1+	6+		1+	6+	1+	6+		
Alabama	AL	FLG-"Size"-AL	\$66	\$64	\$112	\$109	\$154	\$151	\$318	\$312	FLG-"Size"-AL	\$99	\$97	\$149	\$146	\$206	\$203
Alaska	AK	FLG-"Size"-AK	\$66	\$64	\$112	\$109	\$154	\$151	\$318	\$312	FLG-"Size"-AK	\$99	\$97	\$149	\$146	\$206	\$203
Arizona	AZ	FLG-"Size"-AZ	\$66	\$64	\$112	\$109	\$154	\$151	\$318	\$312	FLG-"Size"-AR	\$99	\$97	\$149	\$146	\$206	\$203
Arkansas	AR	FLG-"Size"-AR	\$66	\$64	\$112	\$109	\$154	\$151	\$318	\$312	FLG-"Size"-AZ	\$99	\$97	\$149	\$146	\$206	\$203
California	CA	FLG-"Size"-CA	\$66	\$64	\$112	\$109	\$154	\$151	\$318	\$312	FLG-"Size"-CA	\$99	\$97	\$149	\$146	\$206	\$203
Colorado	CO	FLG-"Size"-CO	\$66	\$64	\$112	\$109	\$154	\$151	\$318	\$312	FLG-"Size"-CO	\$99	\$97	\$149	\$146	\$206	\$203
Connecticut	CT	FLG-"Size"-CT	\$66	\$64	\$125	\$122	\$196	\$191	\$355	\$347	FLG-"Size"-CT	\$111	\$107	\$156	\$153	\$263	\$258
Delaware	DE	FLG-"Size"-DE	\$66	\$64	\$125	\$122	\$196	\$191	\$355	\$347	FLG-"Size"-DE	\$111	\$107	\$156	\$153	\$263	\$258
Florida	FL	FLG-"Size"-FL	\$66	\$64	\$125	\$122	\$196	\$191	\$355	\$347	FLG-"Size"-FL	\$111	\$107	\$156	\$153	\$263	\$258
Georgia	GA	FLG-"Size"-GA	\$66	\$64	\$112	\$109	\$154	\$151	\$355	\$347	FLG-"Size"-GA	\$99	\$97	\$149	\$146	\$206	\$203
Hawaii	HI	FLG-"Size"-HI	\$66	\$64	\$112	\$109	\$154	\$151	\$318	\$312	FLG-"Size"-HI	\$99	\$97	\$149	\$146	\$206	\$203
Idaho	ID	FLG-"Size"-ID	\$66	\$64	\$125	\$122	\$154	\$151	\$318	\$312	FLG-"Size"-ID	\$111	\$107	\$159	\$156	\$263	\$258
Illinois	IL	FLG-"Size"-IL	\$66	\$64	\$125	\$122	\$196	\$191	\$321	\$315	FLG-"Size"-IL	\$111	\$107	\$159	\$156	\$263	\$258
Indiana	IN	FLG-"Size"-IN	\$66	\$64	\$112	\$109	\$154	\$151	\$355	\$347	FLG-"Size"-IN	\$99	\$97	\$149	\$146	\$206	\$203
Iowa	IA	FLG-"Size"-IA	\$66	\$64	\$112	\$109	\$154	\$151	\$318	\$312	FLG-"Size"-IA	\$99	\$97	\$149	\$146	\$206	\$203
Kansas	KS	FLG-"Size"-KS	\$66	\$64	\$125	\$122	\$196	\$191	\$355	\$347	FLG-"Size"-KS	\$111	\$107	\$159	\$156	\$263	\$258
Kentucky	KY	FLG-"Size"-KY	\$66	\$64	\$125	\$122	\$196	\$191	\$355	\$347	FLG-"Size"-KY	\$111	\$107	\$159	\$156	\$263	\$258
Louisiana	LA	FLG-"Size"-LA	\$66	\$64	\$112	\$109	\$154	\$151	\$318	\$312	FLG-"Size"-LA	\$99	\$97	\$149	\$146	\$206	\$203
Maine	ME	FLG-"Size"-ME	\$66	\$64	\$125	\$122	\$196	\$191	\$318	\$312	FLG-"Size"-ME	\$111	\$107	\$159	\$156	\$263	\$258
Maryland	MD	FLG-"Size"-MD	\$66	\$64	\$112	\$109	\$154	\$151	\$318	\$312	FLG-"Size"-MD	\$99	\$97	\$149	\$146	\$206	\$203
Massachusetts	MA	FLG-"Size"-MA	\$66	\$64	\$112	\$109	\$154	\$151	\$318	\$312	FLG-"Size"-MA	\$99	\$97	\$149	\$146	\$206	\$203
Michigan	MI	FLG-"Size"-MI	\$66	\$64	\$125	\$122	\$196	\$191	\$355	\$347	FLG-"Size"-MI	\$111	\$107	\$159	\$156	\$263	\$258
Minnesota	MN	FLG-"Size"-MN	\$66	\$64	\$125	\$122	\$196	\$191	\$355	\$347	FLG-"Size"-MN	\$111	\$107	\$159	\$156	\$263	\$258
Mississippi	MS	FLG-"Size"-MS	\$66	\$64	\$112	\$109	\$154	\$151	\$355	\$347	FLG-"Size"-MS	\$99	\$97	\$149	\$146	\$206	\$203
Missouri	MO	FLG-"Size"-MO	\$66	\$64	\$125	\$122	\$196	\$191	\$355	\$347	FLG-"Size"-MO	\$111	\$107	\$159	\$156	\$263	\$258
Montana	MT	FLG-"Size"-MT	\$66	\$64	\$125	\$122	\$196	\$191	\$318	\$312	FLG-"Size"-MT	\$111	\$107	\$159	\$156	\$263	\$258
Nebraska	NE	FLG-"Size"-NE	\$66	\$64	\$112	\$109	\$154	\$151	\$318	\$312	FLG-"Size"-NE	\$99	\$97	\$149	\$146	\$206	\$203
Nevada	NV	FLG-"Size"-NV	\$66	\$64	\$112	\$109	\$154	\$151	\$318	\$312	FLG-"Size"-NV	\$99	\$97	\$149	\$146	\$206	\$203
New Hampshire	NH	FLG-"Size"-NH	\$66	\$64	\$125	\$122	\$196	\$191	\$355	\$347	FLG-"Size"-NH	\$111	\$107	\$159	\$156	\$263	\$258
New Jersey	NJ	FLG-"Size"-NJ	\$66	\$64	\$125	\$122	\$196	\$191	\$355	\$347	FLG-"Size"-NJ	\$111	\$107	\$159	\$156	\$263	\$258
New Mexico	NM	FLG-"Size"-NM	\$66	\$64	\$112	\$109	\$154	\$151	\$318	\$312	FLG-"Size"-NM	\$99	\$97	\$149	\$146	\$206	\$203
New York	NY	FLG-"Size"-NY	\$66	\$64	\$125	\$122	\$196	\$191	\$355	\$347	FLG-"Size"-NY	\$111	\$107	\$159	\$156	\$263	\$258
North Carolina	NC	FLG-"Size"-NC	\$66	\$64	\$112	\$109	\$154	\$151	\$318	\$312	FLG-"Size"-NC	\$99	\$97	\$149	\$146	\$206	\$203
North Dakota	ND	FLG-"Size"-ND	\$66	\$64	\$125	\$122	\$196	\$191	\$355	\$347	FLG-"Size"-ND	\$111	\$107	\$159	\$156	\$263	\$258
Ohio	OH	FLG-"Size"-OH	\$66	\$64	\$112	\$109	\$154	\$151	\$355	\$347	FLG-"Size"-OH	\$99	\$97	\$149	\$146	\$206	\$203
Oklahoma	OK	FLG-"Size"-OK	\$66	\$64	\$125	\$122	\$196	\$191	\$355	\$347	FLG-"Size"-OK	\$111	\$107	\$159	\$156	\$263	\$258
Oregon	OR	FLG-"Size"-OR	\$148	\$146	\$202	\$198	\$268	\$264	\$415	\$407	FLG-"Size"-OR	\$196	\$191	\$333	\$326	\$412	\$403
Pennsylvania	PA	FLG-"Size"-PA	\$66	\$64	\$125	\$122	\$196	\$191	\$318	\$312	FLG-"Size"-PA	\$111	\$107	\$159	\$156	\$263	\$258
Rhode Island	RI	FLG-"Size"-RI	\$66	\$64	\$112	\$109	\$154	\$151	\$318	\$312	FLG-"Size"-RI	\$99	\$97	\$149	\$146	\$206	\$203
South Carolina	SC	FLG-"Size"-SC	\$66	\$64	\$112	\$109	\$154	\$151	\$318	\$312	FLG-"Size"-SC	\$99	\$97	\$149	\$146	\$206	\$203
South Dakota	SD	FLG-"Size"-SD	\$66	\$64	\$112	\$109	\$154	\$151	\$318	\$312	FLG-"Size"-SD	\$99	\$97	\$149	\$146	\$206	\$203
Tennessee	TN	FLG-"Size"-TN	\$51	\$50	\$112	\$109	\$154	\$151	\$318	\$312	FLG-"Size"-TN	\$99	\$97	\$149	\$146	\$206	\$203
Texas	TX	FLG-"Size"-TX	\$51	\$50	\$66	\$64	\$98	\$96	\$177	\$174	FLG-"Size"-TX	\$77	\$76	\$106	\$102	\$148	\$144
Utah	UT	FLG-"Size"-UT	\$66	\$64	\$125	\$122	\$196	\$191	\$355	\$347	FLG-"Size"-UT	\$111	\$107	\$159	\$156	\$263	\$258
Vermont	VT	FLG-"Size"-VT	\$66	\$64	\$125	\$122	\$196	\$191	\$355	\$347	FLG-"Size"-VT	\$111	\$107	\$159	\$156	\$263	\$258
Virginia	VA	FLG-"Size"-VA	\$66	\$64	\$125	\$122	\$196	\$191	\$355	\$347	FLG-"Size"-VA	\$111	\$107	\$159	\$156	\$263	\$258
Washington	WA	FLG-"Size"-WA	\$111	\$109	\$153	\$149	\$228	\$223	\$371	\$363	FLG-"Size"-WA	\$196	\$191	\$333	\$326	\$412	\$403
West Virginia	WV	FLG-"Size"-WV	\$66	\$64	\$125	\$122	\$196	\$191	\$355	\$347	FLG-"Size"-WV	\$111	\$107	\$159	\$156	\$263	\$258
Wisconsin	WI	FLG-"Size"-WI	\$66	\$64	\$125	\$122	\$196	\$191	\$355	\$347	FLG-"Size"-WI	\$111	\$107	\$159	\$156	\$263	\$258
Wyoming	WY	FLG-"Size"-WY	\$66	\$64	\$112	\$109	\$154	\$151	\$318	\$312	FLG-"Size"-WY	\$99	\$97	\$149	\$146	\$206	\$203

*Nylon Flag Part Number Example:
FLG-0305N-AL (3' X 5' Nylon Alabama Flag)

**Polyester Flag Part Number Example:
FLG-0305P-AL (3' X 5' Polyester Alabama Flag)



Flagpole Balls



The Flagpole Ball is the most commonly used flagpole ornament. Sitting majestically above the flag and pole arrangement, it is considered the finishing touch for today's aluminum flagpole.

Concord American Flagpole offers Balls in a variety of finish and design options, allowing for a truly personal flagpole design. Balls are offered in Butt Diameters ranging from 3" to 24", with the recommended Ball diameter matching the butt diameter of the flagpole. Standard thread sizes are 1/2"-13NC, 5/8"-11NC, and 3/4"-10NC.

Concord American Flagpole's Patented Ball is designed and manufactured to provide unmatched reliability. Natural pole vibration often causes premature flagpole ball failures, leading to high labor costs associated with replacement. Our patented design addresses the many issues seen in the standard ball construction offered by ALL others in the industry.

Heavy-Duty Aluminum Flagpole Ball Industry Exclusive, Patented Ball Construction



Simply The Best
Flagpole Ball Available

Patent #7334535
For Component and Assembly Methods

- A thick-wall, aluminum tube is incorporated as an inner spacer. *Strengthens the assembly while assuring proper compression of the two ball spheres.*
- Thick spherical halves are spun with an extra wide lip at the joint. *Significantly limits the upper half sphere's ability to slide down over the bottom half.*
- A stainless steel bolt and high strength adhesive compound secure the spacer rod at the ball tip. *Eliminates the potential failures seen with rivet or internal mounted nuts.*
- A plated steel jamb nut is provided to secure the Ball to the truck assembly. *Secure, permanent attachment to the flagpole truck.*

- 4" to 8" Balls have ball stems machined from 3/4" diameter 6063 Aluminum and secured with a stainless steel threaded rod and high strength adhesive compound. *Superior strength and protection against the rigors of pole vibration.*

- 10" to 12" Balls are constructed with a 5/8" solid stainless steel threaded rod. *Provides maximum strength for larger ball applications.*



- Heavy-Duty Aluminum Balls available in 4" to 24" Diameters. *Gold Anodized, Clear Anodized, Powder Coated and Satin finishes.*

Gold Anodized Heavy-Duty Aluminum Ball



BALL SIZE	ROD SIZE	PART NUMBER	1+	6+	24+
1/2"-13NC					
4"	1/2"-13NC	BAL-0412-GLD	\$66	\$63	\$61
5"		BAL-0512-GLD	\$73	\$70	\$68
6"		BAL-0612-GLD	\$87	\$82	\$80
8"		BAL-0812-GLD	\$139	\$132	\$129
5/8"- 11NC					
4"	5/8"- 11NC	BAL-0458-GLD	\$66	\$63	\$61
5"		BAL-0558-GLD	\$73	\$70	\$68
6"		BAL-0658-GLD	\$87	\$82	\$80
8"		BAL-0858-GLD	\$139	\$132	\$129
10"		BAL-1058-GLD	\$204	\$191	\$188
12"		BAL-1258-GLD	\$245	\$231	\$228



Clear Anodized Heavy-Duty Aluminum Ball

BALL SIZE	ROD SIZE	PART NUMBER	1+	6+	24+
1/2" Rod					
4"	1/2"-13NC	BAL-0412-ACL	\$66	\$63	\$61
5"		BAL-0512-ACL	\$73	\$70	\$68
6"		BAL-0612-ACL	\$87	\$82	\$80
8"		BAL-0812-ACL	\$139	\$132	\$129
5/8" Rod					
4"	5/8"- 11NC	BAL-0458-ACL	\$66	\$63	\$61
5"		BAL-0558-ACL	\$73	\$70	\$68
6"		BAL-0658-ACL	\$87	\$82	\$80
8"		BAL-0858-ACL	\$139	\$132	\$129
10"		BAL-1058-ACL	\$204	\$191	\$188
12"		BAL-1258-ACL	\$245	\$231	\$228



Powder Coated Heavy-Duty Aluminum Ball

BALL SIZE	ROD SIZE	PART NUMBER	1+	6+	24+
1/2" Rod					
4"	1/2"-13NC	BAL-0412-***	\$73	\$70	\$68
5"		BAL-0512-***	\$80	\$77	\$75
6"		BAL-0612-***	\$96	\$91	\$89
8"		BAL-0812-***	\$153	\$145	\$141
5/8" Rod					
4"	5/8"- 11NC	BAL-0458-***	\$73	\$70	\$68
5"		BAL-0558-***	\$80	\$77	\$75
6"		BAL-0658-***	\$96	\$91	\$89
8"		BAL-0858-***	\$153	\$145	\$141
10"		BAL-1058-***	\$223	\$211	\$207
12"		BAL-1258-***	\$270	\$256	\$251



*** - Powder Coat Options
 BZT = BronzeTone
 BLK = Black
 WHT = White
 CLR = Clear

BronzeTone Shown

Satin Finish Heavy-Duty Aluminum Ball

BALL SIZE	ROD SIZE	PART NUMBER	1+	6+	24+
1/2" Rod					
4"	1/2"- 13NC	BAL-0412-SAT	\$53	\$49	\$47
5"		BAL-0512-SAT	\$58	\$56	\$54
6"		BAL-0612-SAT	\$68	\$65	\$63
8"		BAL-0812-SAT	\$106	\$103	\$101
5/8" Rod					
4"	5/8"- 11NC	BAL-0458-SAT	\$53	\$49	\$47
5"		BAL-0558-SAT	\$58	\$56	\$54
6"		BAL-0658-SAT	\$68	\$65	\$63
8"		BAL-0858-SAT	\$106	\$103	\$101
10"		BAL-1058-SAT	\$141	\$134	\$131
12"		BAL-1258-SAT	\$162	\$153	\$150



Extra-Large Heavy-Duty Aluminum Ball

BALL SIZE	ROD SIZE	PART NUMBER	1+	6+	24+
Gold Tone					
18"	3/4"- 10NC	BAL-1834-GDT	\$1,369	\$1,299	\$1,273
24"		BAL-2434-GDT	\$1,551	\$1,473	\$1,443
Satin					
18"	3/4"- 10NC	BAL-1834-SAT	\$1,268	\$1,204	\$1,179
24"		BAL-2434-SAT	\$1,459	\$1,386	\$1,358



Spun from 1/8" thick aluminum, these 18" and 24" diameter Balls are for use only with Heavy-Duty Truck assemblies and Stainless Steel Spindles.

GOLDTONE SHOWN



Flagpole Balls and Finials

Traditional Construction Ball Ornaments are offered in Gold Anodized, Stainless Steel and 24K Gold Leaf. Texas Star and Christian Cross Finials are available in our GoldTone Powder Coat.



Gold Anodized Aluminum Ball Traditional Construction

BALL SIZE	ROD SIZE	PART NUMBER	1+	6+	24+
1/2"-13NC					
3"	1/2"-13NC	BAL-0312-GLD	\$39	\$37	\$35



Stainless Steel Ball Traditional Construction

BALL SIZE	ROD SIZE	PART NUMBER	1+	6+	24+
1/2"-13NC					
3"	1/2"-13NC	BAL-0312-STC	\$115	\$110	\$108
4"		BAL-0412-STC	\$178	\$169	\$165
5"		BAL-0512-STC	\$245	\$233	\$228
6"		BAL-0612-STC	\$252	\$240	\$235
8"		BAL-0812-STC	\$414	\$393	\$384
5/8"- 11NC					
4"	5/8"- 11NC	BAL-0458-STC	\$178	\$169	\$165
5"		BAL-0558-STC	\$245	\$233	\$228
6"		BAL-0658-STC	\$252	\$240	\$235
8"		BAL-0858-STC	\$414	\$393	\$384
10"		BAL-1058-STC	\$645	\$612	\$600
12"		BAL-1258-STC	\$863	\$820	\$803



24k Gold Leaf Copper Ball Traditional Construction

BALL SIZE	ROD SIZE	PART NUMBER	1+	
1/2"-13NC				
4"	1/2"-13NC	BAL-0412-GLC	Pricing for Gold Leaf Copper Balls are subject to change due to the fluctuation in the market price of Gold. Please contact Concord American Flagpole Customer Service for price confirmation.	
5"		BAL-0512-GLC		
6"		BAL-0612-GLC		
8"		BAL-0812-GLC		
5/8"- 11NC				
4"	5/8"- 11NC	BAL-0458-GLC		
5"		BAL-0558-GLC		
6"		BAL-0658-GLC		
8"		BAL-0858-GLC		
10"		BAL-1058-GLC		
12"		BAL-1258-GLC		



TSF-0100-GDT
TSF-0200-GDT



CCF-1006-GDT

Finials

SIZE	ROD SIZE	PART NUMBER	1+	6+	24+
Texas Star					
8"	1/2"-13NC	TSF-0100-GDT	\$138	\$131	\$127
12"	5/8"- 11NC	TSF-0200-GDT	\$275	\$256	\$251
Christian Cross					
9"	1/2"-13NC	CCF-1006-GDT	\$138	\$131	\$127

Texas Star and Christian Finials are the perfect complement for use atop flagpoles flying Texas or Christian flags. Each is constructed of heavy cast aluminum with steel attachment rod and finished in our GoldTone Powder Coat finish.



Use to modify trucks with existing 5/8"-11NC drillings to accept Balls/Ornaments with 1/2"-13NC threads.

Thread Adaptor

THREADED ROD SIZE CONVERSION	PART NUMBER	1+	6+	24+
Converts 1/2"-13NC to 5/8"-11NC	THA-1258	\$115	\$106	\$105
Converts 5/8"-11NC to 1/2"-13NC	THA-5812	\$115	\$106	\$105



Eagles



Eagles - Cast Aluminum

DESCRIPTION	OVERALL WINGSPAN	WING-TIP TO WING-TIP	ROD SIZE	PART NUMBER	1+	6+	18+
Gold Tone							
Flying Eagle/Ball	8"	6"	1/2"-13NC	EAG-0100-GDT	\$79	\$74	\$71
Flying Eagle/Ball	12"	9"	1/2"-13NC	EAG-0300-GDT	\$123	\$117	\$113
Landed Eagle/Ball	11"	7"	1/2"-13NC	EAG-0200-GDT	\$95	\$88	\$87
Flying Eagle	15"	9"	1/2"-13NC	EAG-0450-GDT	\$162	\$153	\$149
Flying Eagle	27"	15"	1/2"-13NC	EAG-0550-GDT	\$242	\$228	\$225
Flying Eagle On 3" Ball	15"	9"	1/2"-13NC	EAG-0460-GDT	\$171	\$160	\$159
Flying Eagle On 3" Ball	27"	15"	1/2"-13NC	EAG-0560-GDT	\$265	\$254	\$248
Natural Colors							
Flying Eagle	15"	9"	1/2"-13NC	EAG-0450-NAT	\$201	\$192	\$189
Flying Eagle	27"	15"	1/2"-13NC	EAG-0550-NAT	\$322	\$305	\$298
Flying Eagle On 3" Ball	15"	9"	1/2"-13NC	EAG-0460-NAT	\$233	\$223	\$220
Flying Eagle On 3" Ball	27"	15"	1/2"-13NC	EAG-0560-NAT	\$358	\$339	\$333

Cast Aluminum Eagles provide style and size options for all flagpole heights. Standard options include Eagle Only and Eagle On Ball in both GoldTone and Natural Color finish options. Overall Wingspan is measured from wing-tip, across back, to opposite wing-tip and is approximate.

Note: Wingspan in inches should approximate 1/2 of flagpole height in feet.

Extra-Large Flying Eagle - Cast Aluminum

The Extra-Large Cast Aluminum Eagle is designed for larger Internal and External flagpoles up to 100'. It requires the use of a Heavy-Duty, External Halyard Truck Assembly (See Page 63), a Heavy-Duty Truck Assembly with an 12" Heavy-Duty Aluminum Cast Ball Truck, or the 12" External or Internal Ball Truck Assembly (See Pages 65 and 68). A Stainless Steel Spindle (See Page 69) in the Truck or Ball Truck is also required. Contact Customer Service for pricing and for information on color options and special applications.





External Trucks

External Flagpole Trucks sit at the top of each flagpole, providing an exposed pulley and rope system for raising and lowering the flag.

All Trucks are designed to accept Balls, Eagles and Finials. Standard Spindle Threading is 1-1/4" NPT (1" NPT and 1-1/2" NPT Spindles available upon request). External Halyard Trucks may be combined to achieve quantity discounts.

Cap Design Trucks install over the top of the flagpole and are attached with anchoring set screws or bolts. Spindle Design Trucks incorporate a threaded spindle which is installed into a female fitting welded into the top of the flagpole. Stationary Trucks are fixed and will not rotate. Revolving Trucks rotate the flag with the wind.

*** - Specify Powder Coat Option
 BZT = BronzeTone WHT = White
 BLK = Black CLR = Clear



External Stationary - Cap Design External Single Revolving - Spindle Design External Double Revolving - Spindle Design

External Halyard - Cap Style Single Stationary Truck



- Cast Aluminum Body.
- Aluminum Pulley on Stainless Steel Axle. Nylon Pulley on Stainless Steel Axle available in sizes to 3".
- 1/2"-13NC Top Drilling (5/8"-11NC Available).
- Recommended Halyard Diameter - 5/16".
- Stainless Steel Set Screws (3) on sizes to 3-1/2" or Stainless Steel Bolts (3) on sizes 4" and larger are provided.
- See Page 64 - External Halyard Cap Style Single Revolving Truck for options to convert Stationary flagpoles into Revolving systems.

PART NUMBER	SHAFT TOP DIAMETER	PULLEY	1+	6+	18+
Satin Finish					
TRK-9100	1-7/8" - 2"	Nylon	\$46	\$44	\$42
TRK-9101	1-7/8" - 2"	Aluminum	\$65	\$63	\$61
TRK-9200	2-3/8" - 2-1/2"	Nylon	\$60	\$56	\$53
TRK-9201	2-3/8" - 2-1/2"	Aluminum	\$77	\$75	\$72
TRK-9300	2-7/8" - 3"	Nylon	\$61	\$58	\$56
TRK-9301	2-7/8" - 3"	Aluminum	\$79	\$77	\$73
TRK-9320	3-1/2"	Aluminum	\$96	\$93	\$89
TRK-9210	4"	Aluminum	\$190	\$183	\$176
TRK-9220	4-1/2"	Aluminum	\$206	\$196	\$190
TRK-9230	5"	Aluminum	\$231	\$223	\$214
TRK-9240	5-1/2"	Aluminum	\$247	\$234	\$226
Powder Coat					
TRK-9100-***	1-7/8" - 2"	Nylon	\$56	\$53	\$51
TRK-9101-***	1-7/8" - 2"	Aluminum	\$73	\$72	\$68
TRK-9200-***	2-3/8" - 2-1/2"	Nylon	\$68	\$65	\$63
TRK-9201-***	2-3/8" - 2-1/2"	Aluminum	\$86	\$84	\$80
TRK-9300-***	2-7/8" - 3"	Nylon	\$70	\$66	\$63
TRK-9301-***	2-7/8" - 3"	Aluminum	\$87	\$86	\$80
TRK-9320-***	3-1/2"	Aluminum	\$108	\$103	\$99
TRK-9210-***	4"	Aluminum	\$202	\$193	\$185
TRK-9220-***	4-1/2"	Aluminum	\$217	\$206	\$200
TRK-9230-***	5"	Aluminum	\$247	\$237	\$228
TRK-9240-***	5-1/2"	Aluminum	\$262	\$250	\$240

External Halyard - In-Line Single Revolving Truck



- In-Line Cast Aluminum Body.
- Single Aluminum Pulley on Stainless Steel Axle.
- Upper and Lower Stainless Steel Ball Bearing Assemblies.
- 1-1/4" NPT Spindle.
- 1/2"-13NC Top Drilling.
- Recommended Halyard Diameter - 5/16".

PART NUMBER	SHAFT TOP DIAMETER	1+	6+	18+
Satin Finish				
TRK-9610	4"	\$127	\$122	\$119
Powder Coat				
TRK-9610-***	4"	\$148	\$143	\$138



External Halyard - Double Revolving Truck

PART NUMBER	SHAFT TOP DIAMETER	1+	6+	18+
Satin Finish				
TRK-9709	4"	\$186	\$162	\$160
Powder Coat				
TRK-9709-***	4"	\$214	\$186	\$183

- Cast Aluminum Body.
- Double Aluminum Pulleys on Stainless Steel Axles.
- Upper and Lower Stainless Steel Ball Bearing Assemblies.
- Non-Fouling Design.
- 1-1/4" NPT Spindle.
- 1/2"-13NC Top Drilling (5/8"-11NC Available).
- Recommended Halyard Diameter – 5/16".



External Halyard - Heavy-Duty Single Revolving Truck

PART NUMBER	SHAFT TOP DIAMETER	1+	6+	18+
Satin Finish				
TRK-9420	4-1/2"	\$337	\$325	\$315
TRK-9430	7-1/2"	\$499	\$478	\$459
Powder Coat				
TRK-9420-***	4-1/2"	\$363	\$349	\$334
TRK-9430-***	7-1/2"	\$534	\$513	\$490

- Heavyweight Cast Aluminum Body and Components.
- Single Aluminum Pulley with Stainless Steel Axle.
- SEALED Upper and Lower Stainless Steel Ball Bearing Assemblies.
- 1-1/4" NPT Spindle.
- 1/2"-13NC Top Drilling (5/8"-11NC Available).
- Recommended Halyard Diameter – 3/8".
- Stainless Steel Spindles Available (Add "SS" to Part Number – Example TRK-9416SS-GDT- Add \$340)



External Halyard - Heavy-Duty Double Revolving Truck

PART NUMBER	SHAFT TOP DIAMETER	1+	6+	18+
Satin Finish				
TRK-9975	5-1/2"	\$381	\$367	\$351
TRK-9750	9"	\$799	\$766	\$735
Powder Coat				
TRK-9975-***	5-1/2"	\$421	\$403	\$388
TRK-9750-***	9"	\$862	\$829	\$792

- Heavyweight Cast Aluminum Body and Components.
- Double Aluminum Pulleys with Stainless Steel Axle.
- SEALED Upper and Lower Stainless Steel Ball Bearing Assemblies.
- 1-1/4" NPT Spindle.
- 1/2"-13"NC Top Drilling
- Recommended Halyard Diameter – 3/8".
- Stainless Steel Spindles Available (Add "SS" to Part Number – Example TRK-9416SS-GDT- Add \$340)



Use to modify original External Stationary systems (or Revolving systems with damaged top insert threads) into a Revolving system. Contact Customer Service for applications requiring larger custom sizes.



NYLON PULLEY AVAILABLE

- Cast Aluminum Truck Body and Adapter.
- Single Nylon or Aluminum Pulley on Stainless Steel Axle.
- Attach with three (3) Stainless Steel Set Screws.
- Upper and Lower Stainless Steel Ball Bearing Assemblies.

External Halyard Cap Style Single Revolving Truck

PART NUMBER	SHAFT TOP DIAMETER	PULLEY	1+	6+	18+
Satin Finish					
TRK-9350	1-7/8" - 2"	Nylon	\$163	\$157	\$149
TRK-9351	1-7/8" - 2"	Aluminum	\$183	\$177	\$171
TRK-9365	2-3/8" - 2-1/2"	Nylon	\$175	\$169	\$161
TRK-9366	2-3/8" - 2-1/2"	Aluminum	\$196	\$189	\$183
TRK-9370	2-7/8" - 3"	Nylon	\$181	\$175	\$167
TRK-9371	2-7/8" - 3"	Aluminum	\$202	\$194	\$189
Powder Coat					
TRK-9350	1-7/8" - 2"	Nylon	\$188	\$181	\$174
TRK-9351	1-7/8" - 2"	Aluminum	\$207	\$198	\$191
TRK-9365	2-3/8" - 2-1/2"	Nylon	\$198	\$191	\$183
TRK-9366	2-3/8" - 2-1/2"	Aluminum	\$218	\$211	\$202
TRK-9370	2-7/8" - 3"	Nylon	\$202	\$193	\$185
TRK-9371	2-7/8" - 3"	Aluminum	\$219	\$212	\$204

• 1/2"-13NC Top Drilling (5/8"-11NC Available). • Recommended Halyard Dia. - 5/16".



- Cast Aluminum construction.
- Tapped 1-1/4" NPT.
- Up to 2-1/2" Shaft Top Diameter provided with three (3) Stainless Steel Set Screws.
- 3"+ sizes provided with four (4) Stainless Steel Set Screws.



Create External Revolving Systems from existing Stationary systems (or Revolving systems with damaged top insert threads). Revolving Trucks sold separately.

*** - Specify Powder Coat Option
 BZT = Bronze Tone
 BLK = Black
 WHT = White
 CLR = Clear

Custom larger sizes available. Contact Customer Service for size and pricing options.

Cap Style Truck Adapters

PART NUMBER	SHAFT TOP DIAMETER	1+	6+	18+
Satin Finish				
TRK-2000	2"	\$93	\$88	\$85
TRK-2020	2-3/8"	\$109	\$103	\$100
TRK-2010	2-1/2"	\$124	\$118	\$114
TRK-2030	3"	\$140	\$133	\$129
TRK-2045	3-1/2"	\$156	\$148	\$143
TRK-2050	4"	\$171	\$163	\$158
TRK-2055	4-1/2"	\$187	\$178	\$172
TRK-2061	5"	\$203	\$193	\$187
TRK-2070	5-1/2"	\$218	\$208	\$201
Powder Coat				
TRK-2000-***	2"	\$110	\$104	\$101
TRK-2020-***	2-3/8"	\$126	\$120	\$116
TRK-2010-***	2-1/2"	\$142	\$135	\$130
TRK-2030-***	3"	\$157	\$149	\$145
TRK-2045-***	3-1/2"	\$173	\$164	\$159
TRK-2050-***	4"	\$189	\$179	\$174
TRK-2055-***	4-1/2"	\$204	\$194	\$188
TRK-2061-***	5"	\$220	\$209	\$202

External Halyard Mega-Trucks & Mega Ball Trucks

Concord American Flagpole offers a wide selection of large external halyard trucks... MEGA-TRUCKS... which are designed to be used on poles with top diameters up to 36". All components are significantly strengthened to address the demands placed on them. Stainless Steel Spindles and SEALED bearings are standard. EXTRA-LARGE, heavy gauge aluminum Balls in diameters of 18" and 24" with Stainless Steel Spindles (See Page 59) and 44" Cast Aluminum Flying Eagles (See Page 61) are manufactured for use with MEGA-TRUCKS. MEGA-TRUCKS are the perfect solution for use with cell towers, large light poles and other special applications. Contact Customer Service with your specific requirements.

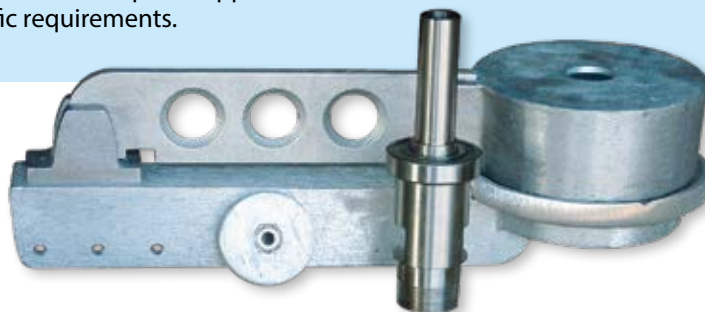

External Ball Truck

Concord American Flagpole's Ball Truck designs combine the function of the truck assembly with the ornamental features of a ball finial. With superior aesthetics and unmatched durability, these heavy-duty designs offer Architects, Specifiers and Project Owners a unique and durable truck assembly option.



*** - Specify Powder Coat Option
 BZT = BronzeTone
 BLK = Black
 WHT = White
 CLR = Clear

External Halyard – 8" & 10" Cast Ball Truck Heavy-Duty Single Revolving

PART NUMBER	DESCRIPTION	SHAFT TOP DIAMETER	1+	3+	7+
Satin Finish					
TRK-9446	8" Cast Ball Truck	4 1/2"	\$466	\$447	\$438
TRK-9416	10" Cast Ball Truck	5"	\$778	\$749	\$733
GoldTone					
TRK-9446-GDT	8" Cast Ball Truck	4 1/2"	\$530	\$508	\$497
TRK-9416-GDT	10" Cast Ball Truck	5"	\$848	\$811	\$796
Powder Coat					
TRK-9446-***	8" Cast Ball Truck	4 1/2"	\$530	\$508	\$497
TRK-9416-***	10" Cast Ball Truck	5"	\$848	\$811	\$796

- Cast Aluminum construction with GoldTone Powder Coated finish.
- Aluminum Pulley on Stainless Steel Axle.
- SEALED Upper and Lower Stainless Steel Ball Bearing Assemblies.
- 1-1/4" NPT Spindle. Stainless Steel Spindle option available (Add "SS" to Part Number – Example TRK-9446SS-GDT- Add \$340).
- Factory-Attached Eagles are available. Contact Customer Service for size and pricing options.



External Halyard – 12" Cast Ball Truck Heavy-Duty Single Revolving

PART NUMBER	DESCRIPTION	1+	3+	7+
Satin Finish				
TRK-9456	12"	\$1,176	\$1,131	\$1,108
GoldTone				
TRK-9456-GDT	12"	\$1,277	\$1,232	\$1,207
Powder Coat				
TRK-9456-***	12"	\$1,277	\$1,232	\$1,207

- Cast Aluminum construction with GoldTone Powder Coated finish.
- Aluminum Pulley on Stainless Steel Axle.
- SEALED Upper and Lower Stainless Steel Ball Bearing Assemblies.
- 1-1/4" NPT Spindle. Stainless Steel Spindle option available (Add "SS" to Part Number – Example TRK-9416SS-GDT- Add \$340)
- Factory-Attached Eagles are available. Contact Customer Service for size and pricing options.



External Halyard – Cast Ball Truck Cap Style Stationary

PART NUMBER	DESCRIPTION	BALL DIAMETER	1+	3+	7+
Satin Finish					
TRK-9126	2" Diameter Cast Ball Truck	4-1/2"	\$101	\$96	\$94
TRK-9136	3" Diameter Cast Ball Truck	6-1/2"	\$146	\$143	\$139
GoldTone					
TRK-9126-GDT	2" Diameter Cast Ball Truck	4-1/2"	\$129	\$119	\$117
TRK-9136-GDT	3" Diameter Cast Ball Truck	6-1/2"	\$174	\$165	\$162

- Cast Aluminum construction with GoldTone Powder Coated finish.
- Nylon Pulley on Stainless Steel Axle.
- Attaches with a Stainless Steel Set Screw (provided).





Internal Trucks

Internal Flagpole Trucks sit at the top of the flagpole, providing a system that encloses either Rope Halyard (*Cam Cleat Systems*) or Wire Halyard (*Winch Systems*) behind the security of a lockable access door. Internal Trucks are offered in Stationary and Revolving options (*See Pages 8-9*) in

either Cap Style or Threaded Spindle designs. All Trucks are designed to accept Balls, Eagles and Finials. Internal Halyard Trucks may be combined to achieve quantity discounts.

*** - Specify Powder Coat Option
 BZT = BronzeTone WHT = White
 BLK = Black CLR = Clear



Internal Single Stationary - Cap Design

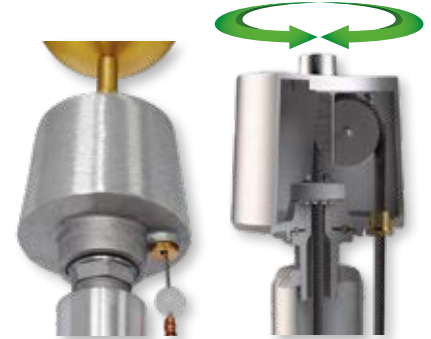

Internal Revolving - Spindle Design

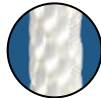

Internal Halyard Stationary Truck Rope Halyard

PART NUMBER	SHAFT TOP DIAMETER	PULLEY	1+	3+	7+
Satin Finish					
TRK-9901	3"	Nylon	\$93	\$87	\$84
TRK-9902	3"	Aluminum	\$110	\$105	\$101
TRK-9911	3-1/2"	Nylon	\$136	\$131	\$126
TRK-9912	3-1/2"	Aluminum	\$155	\$148	\$143
Powder Coat					
TRK-9901-***	3"	Nylon	\$105	\$99	\$94
TRK-9902-***	3"	Aluminum	\$122	\$117	\$113
TRK-9911-***	3-1/2"	Nylon	\$150	\$141	\$136
TRK-9912-***	3-1/2"	Aluminum	\$167	\$160	\$153

- Cast Aluminum Body.
- External Aluminum or Nylon Pulley on Stainless Steel Axle. Internal Nylon Pulley.
- Attached with three (3) Stainless Steel Set Screws.
- 1/2"-13"NC Top Drilling (5/8"-11NC Available).
- Recommended Halyard Diameter - 5/16".
- Contact Customer Service for applications requiring larger custom sizes.

Internal Halyard - Standard Cone Style Revolving Truck Wire or Rope Halyard



PART NUMBER	DESCRIPTION	MAX SHAFT TOP DIAMETER	1+	3+	7+
Satin Finish					
TRK-9660	SMALL - Dual SEALED Bearing Assemblies	3-1/2"	\$450	\$428	\$410
Powder Coat					
TRK-9660-***	SMALL - Dual SEALED Bearing Assemblies	3-1/2"	\$508	\$481	\$462

- Constructed from heavy Cast Aluminum in a two-piece, removable hood design.
- Internal, Cast Aluminum Pulley.
- Cast Brass Halyard Exit Bushing reduces wear, significantly increasing Truck life.
- Includes Dual SEALED Bearing Assemblies.
- 1-1/4" NPT Spindle. Stainless Steel Spindle option available only on TRK-9660. (Add "SS" to Part Number - Example TRK-9660SS- Add \$340).
- 1/2"-13"NC Top Drilling (5/8"-11NC Available).

Internal Halyard - Large Cone Style Revolving Truck Wire Halyard

PART NUMBER	DESCRIPTION	MAX SHAFT TOP DIAMETER	1+	3+	7+
Satin Finish					
TRK-9800	LARGE - Dual SEALED Bearing Assemblies	4-1/2"	\$685	\$650	\$624
Powder Coat					
TRK-9800-***	LARGE - Dual SEALED Bearing Assemblies	4-1/2"	\$730	\$693	\$666

- Constructed from heavy Cast Aluminum in a two-piece, removable hood design.
- Internal, Cast Aluminum Pulley.
- Cast Brass Halyard Exit Bushing reduces wear, significantly increasing Truck life.
- 1/2"-13NC Top Drilling (5/8"-11NC Available).
- 1-1/4" NPT Spindle. Stainless Steel Spindle option available (Add "SS" to Part Number – Example TRK-9800SS - Add \$340).



Internal Halyard - Extra-Large Cone Style Revolving Truck Wire Halyard

PART NUMBER	DESCRIPTION	MAX SHAFT TOP DIAMETER	1+	3+	7+
Satin Finish					
TRK-9900	EXTRA-LARGE - Dual SEALED Bearing Assemblies	7-1/2"	\$1,077	\$1,021	\$980
Powder coat					
TRK-9900-***	EXTRA-LARGE - Dual SEALED Bearing Assemblies	7-1/2"	\$1,159	\$1,094	\$1,051

- Constructed from heavy Cast Aluminum in a two-piece, removable hood design.
- Internal, Cast Aluminum Pulley.
- Cast Brass Halyard Exit Bushing reduces wear, significantly increasing Truck life.
- 1/2"-13NC Top Drilling (5/8"-11NC Available).
- 1-1/4" NPT Spindle. Stainless Steel Spindle option available (Add "SS" to Part Number – Example TRK-9900SS - Add \$340).



Internal Ball Truck

Concord American Flagpole's Ball Truck combines the function of the truck assembly with the ornamental features of a ball finial, offering Architects, Specifiers and Project Owners a unique truck assembly with superior aesthetics and unmatched durability.

- Cast Aluminum construction with GoldTone Powder Coated finish.
- Internal, Aluminum Pulley.
- SEALED Upper and Lower Stainless Steel Ball Bearing Assemblies.
- Cast Brass Halyard Exit Bushing reduces wear, significantly increasing Truck life.

- Factory-Attached Eagles are available. Extra-Large Flying Eagle available only on TRK-9856 and TRK-9876. Contact Customer Service for size and pricing options.

Internal Halyard – 8" and 10" Cast Ball Truck

For Use With Wire or Rope Halyard Cam Cleat Flagpole Systems



PART NUMBER	CAST BALL SIZE	MAX SHAFT TOP DIAMETER	1+	3+	7+
Satin Finish					
TRK-9646	8"	3-1/2"	\$483	\$466	\$455
TRK-9616	10"	4"	\$778	\$749	\$733
Powder coat					
TRK-9646-***	8"	3-1/2"	\$539	\$516	\$506
TRK-9616-***	10"	4"	\$832	\$799	\$784
Gold Tone					
TRK-9646-GDT	8"	3-1/2"	\$539	\$516	\$506
TRK-9616-GDT	10"	4"	\$832	\$799	\$784



Internal Halyard – 12" Cast Ball Truck

For Use With Wire Halyard Winch Flagpole Systems

PART NUMBER	CAST BALL SIZE	MAX SHAFT TOP DIAMETER	1+	3+	7+
Satin Finish					
TRK-9856	12"	4-1/2"	\$957	\$912	\$895
Powder Coat					
TRK-9856-***	12"	4-1/2"	\$1,034	\$985	\$966
Gold Tone					
TRK-9856-GDT	12"	4-1/2"	\$993	\$947	\$928



Internal Halyard – 18" and 24" Spun Ball Truck

For Use With Wire Halyard Winch Flagpole Systems

PART NUMBER	CAST BALL SIZE	MAX SHAFT TOP DIAMETER	1+	3+	7+
Powder Coat					
TRK-9876-***	18"	7-1/2"	\$2,252	\$2,160	\$2,117
TRK-9878-***	24"	7-1/2"	\$3,220	\$3,091	\$3,027
Gold Tone					
TRK-9876-GDT	18"	7-1/2"	\$2,252	\$2,160	\$2,117
TRK-9878-GDT	24"	7-1/2"	\$3,220	\$3,091	\$3,027

**Stainless Steel Spindles are Standard on 24" Spun Aluminum Ball Trucks.

Stainless Steel Truck Spindles

For Revolving Truck Assemblies

Stainless Steel Spindles are strongly recommended for special applications that put considerable stress on the truck and spindle assemblies. Examples include large Eagles, tall flagpoles, roof mount applications, flagpoles flying extremely large or multiple flags and high wind areas. Several spindle lengths and NPT thread size combinations are available.

Contact Customer Service for availability, specification assistance, and pricing.



Selecting the correct thread size for a spindle based revolving truck:

- Threads that are cut in an NPT (National Pipe Thread) format are measured and expressed differently than National Coarse (NC) or National (NF) threads. When determining the proper thread for a spindle assembly, the following approximate dimensions for measuring across the bottom of the spindle should help determine the NPT size to be ordered. As a reminder, pipe threads are tapered but this should be close enough for size determination. Unless otherwise stated, all Revolving Truck Assemblies offered in this catalog have a 1 1/4" NPT spindles.

National Pipe Thread (NPT) Size	Approximate Measurement at the Spindle Base
1" NPT	1 1/4"
1 1/4" NPT	1 5/8"
1 1/2" NPT	1 7/8"

Side Mount Trucks for Light Poles

Turns Existing Poles Into A Flag or Banner Pole

- Easily allows the raising, lowering and changing of flags, banners or pennants without hoists or ladders.
- Professional results without the need to drill the pole.
- Flags or messaging can be quickly changed or removed in inclement weather.
- Attach using two (2) Stainless Steel Hose Clamps (*by others*). Design does accommodate bolting if desired.
- Cleat Adapter is available for Cleat installation without pole drilling. Adapter attaches with two (2) Stainless Steel Hose Clamps (*by others*).

Side Mount Kit consists of the following parts.

- TRK-9160 Side Mount Truck.
- CLA-9060 6" Cleat with two (2) Stainless Steel Screws.
- CLA-9900 Cleat Adapter.
- CLA-0200 Nickle Plated Flagsnaps – Qty. (2).
- SNP-0500-WHT White Flagsnap Covers – Qty. (2).
- HAL-0710 Polyester Rope Halyard – Qty. 55'.

PART NUMBER	DESCRIPTION	1+	6+	18+
Satin Finish				
TRK-1000	Complete Side Mount Kit	\$124	\$120	\$115
TRK-9160	Side Mount Truck ONLY	\$37	\$35	\$33
CLA-9900	Cleat Adapter	\$13	\$11	\$9
Powder Coat				
TRK-1000-***	Complete Side Mount Kit	\$141	\$136	\$132
TRK-9160-***	Side Mount Truck ONLY	\$49	\$47	\$46
CLA-9900-***	Cleat Adapter	\$21	\$20	\$18



Rope Halyard

Concord American Flagpole offers a complete line of Rope Halyards that are specially designed for the rigorous demands of outdoor flagpole systems. Available in various size and material specifications, all are braided, multifilament styles containing a smooth and rounded form perfect for flagpole pulley applications. For use in both External and Internal Cam Cleat applications.

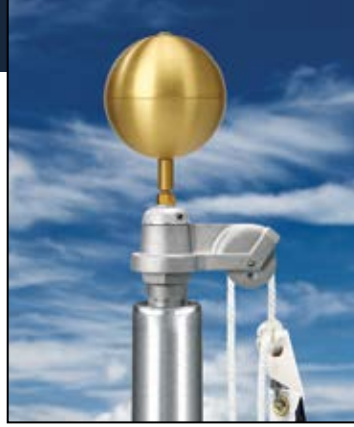

Spools
Spools of Polyester, Nylon and Wire Core Rope Halyard are available.

Polyester Halyard

Polyester Halyard

Strong, lightweight and rot and mildew resistant, Polyester Halyard combines good flexibility and shock load absorption with excellent resistance to abrasion.



WHITE POLYESTER ROPE



BRONZETONE POLYESTER ROPE



BLACK POLYESTER ROPE



SILVER POLYESTER ROPE



PART NUMBER	DESCRIPTION	TYPICAL SPOOL LENGTH	<500'	500'+	1,000'+
			*Price per foot		
White					
HAL-0705-WHT	1/4" - Polyester #8	1,000'	\$0.50	\$0.47	\$0.40
HAL-0710-WHT	5/16" - Polyester #10	1,000'	\$0.70	\$0.64	\$0.60
HAL-0715-WHT	3/8" - Polyester #12	500'	\$1.01	\$0.90	\$0.87
Bronzestone					
HAL-0705-BZT	1/4" - Polyester #8	500'	\$0.54	\$0.50	\$0.44
HAL-0710-BZT	5/16" - Polyester #10	1,000'	\$0.74	\$0.67	\$0.64
HAL-0715-BZT	3/8" - Polyester #12	500'	\$0.90	\$0.83	\$0.76
Black					
HAL-0705-BLK	1/4" - Polyester #8	1,000'	\$0.54	\$0.50	\$0.44
HAL-0710-BLK	5/16" - Polyester #10	1,000'	\$0.74	\$0.67	\$0.64
HAL-0715-BLK	3/8" - Polyester #12	500'	\$0.90	\$0.83	\$0.76
Silver					
HAL-0705-SIL	1/4" - Polyester #8	1,000'	\$0.54	\$0.50	\$0.44
HAL-0710-SIL	5/16" - Polyester #10	1,000'	\$0.74	\$0.67	\$0.64

Polyester Wire Core Halyard

PART NUMBER	DESCRIPTION	TYPICAL SPOOL LENGTH	<500'	500'+	1,000'+
			*Price per foot		
White					
HAL-0750-WHT	1/4" - Polyester Wire Core #8	500'	\$1.22	\$1.11	\$1.01
HAL-0760-WHT	5/16" - Polyester Wire Core #10	500'	\$1.38	\$1.27	\$1.18
HAL-0770-WHT	3/8" - Polyester Wire Core #12	500'	\$1.88	\$1.74	\$1.58
Bronzestone					
HAL-0750-BZT	1/4" - Polyester Wire Core #8	500'	\$1.22	\$1.11	\$1.01
HAL-0760-BZT	5/16" - Polyester Wire Core #10	500'	\$1.41	\$1.27	\$1.18
HAL-0770-BZT	3/8" - Polyester Wire Core #12	500'	\$1.88	\$1.71	\$1.58
Black					
HAL-0750-BLK	1/4" - Polyester Wire Core #8	500'	\$1.22	\$1.11	\$1.01
HAL-0760-BLK	5/16" - Polyester Wire Core #10	500'	\$1.41	\$1.27	\$1.18
HAL-0770-BLK	3/8" - Polyester Wire Core #12	500'	\$1.88	\$1.71	\$1.58
Silver					
HAL-0750-SIL	1/4" - Polyester Wire Core #8	500'	\$1.22	\$1.11	\$1.01
HAL-0760-SIL	5/16" - Polyester Wire Core #10	500'	\$1.41	\$1.27	\$1.18
HAL-0770-SIL	3/8" - Polyester Wire Core #12	500'	\$1.88	\$1.71	\$1.58

Wire Center Halyard

The strongest of the External Rope Halyard family, Wire Halyard greatly reduces the chance of halyard failure by adding the security of a multi-stranded cable inside a Polyester or Nylon shell.



WHITE POLYESTER WIRE CORE ROPE



BRONZETONE POLYESTER WIRE CORE ROPE



BLACK POLYESTER WIRE CORE ROPE



SILVER POLYESTER WIRE CORE ROPE



Nylon Halyard

Combining superior elasticity, rot and UV resistance with the ability to more efficiently absorb shock loads, Nylon Halyard provides superior strength and performance.



WHITE NYLON ROPE

Nylon Halyard

PART NUMBER	DESCRIPTION	TYPICAL SPOOL LENGTH	<500'	500'+	1,000'+
			*Price per foot		
White					
HAL-0700-WHT	1/4" - Nylon #8	1,000'	\$0.50	\$0.47	\$0.40
HAL-0320-WHT	5/16" - Nylon #10	1,000'	\$0.70	\$0.64	\$0.57
HAL-0420-WHT	3/8" - Nylon #12	500'	\$1.01	\$0.90	\$0.83

Nylon Wire Core Halyard

PART NUMBER	DESCRIPTION	TYPICAL SPOOL LENGTH	<500'	500'+	1,000'+
			*Price per foot		
White					
HAL-0250-WHT	1/4" - Nylon Wire Core #8	500'	\$1.22	\$1.11	\$1.01
HAL-0350-WHT	5/16" - Nylon Wire Core #10	500'	\$1.38	\$1.27	\$1.18
HAL-0450-WHT	3/8" - Nylon Wire Core #12	500'	\$1.88	\$1.74	\$1.58



WHITE NYLON WIRE CORE ROPE

Internal Halyard Cam Cleat Rope Assembly

Cam Cleat Rope Assemblies are designed for rope-based halyard systems utilizing a Cam Cleat mechanism to secure the Rope Halyard within the flagpole. Constructed with 5/16" Polyester Rope in both Wire Core or Standard designs, assemblies incorporate a stainless steel yoke attached with a machine set aluminum crimp. Each option includes a nylon safety stop for placement below the cam cleat, creating the safest Cam Cleat halyard system in the industry!



CAM CLEAT POLYESTER ROPE

COMPLETE CAM CLEAT ROPE HALYARD KIT



For a complete Cam Cleat Rope Replacement System, Order with Rope Assembly. Add two (2) LNK-0300 Stainless Steel Connecting Links (See Page 82), a Counterweight and Retainer Ring Assembly (See Page 75), and two (2) each Flagnaps and Flagnap Covers (See Page 74).

Cam Cleat Polyester Rope Assembly

POLE HEIGHT	DESCRIPTION	PART NUMBER	1+	4+	PART NUMBER	1+	4+
20'	5/16" - Polyester #10	RHA-0200-WHT	\$44	\$39	RHA-0200-BZT	\$58	\$51
25'	5/16" - Polyester #10	RHA-0250-WHT	\$51	\$46	RHA-0250-BZT	\$67	\$60
30'	5/16" - Polyester #10	RHA-0300-WHT	\$60	\$53	RHA-0300-BZT	\$79	\$69
35'	5/16" - Polyester #10	RHA-0350-WHT	\$68	\$61	RHA-0350-BZT	\$90	\$81
40'	5/16" - Polyester #10	RHA-0400-WHT	\$77	\$70	RHA-0400-BZT	\$102	\$92



Cam Cleat Polyester Wire Core Rope Assembly

POLE HEIGHT	DESCRIPTION	PART NUMBER	1+	4+	PART NUMBER	1+	4+
20'	5/16" - Polyester Wire Core #10	RHA-1200-WHT	\$46	\$40	RHA-1200-BZT	\$60	\$53
25'	5/16" - Polyester Wire Core #10	RHA-1250-WHT	\$54	\$49	RHA-1250-BZT	\$72	\$65
30'	5/16" - Polyester Wire Core #10	RHA-1300-WHT	\$63	\$56	RHA-1300-BZT	\$83	\$74
35'	5/16" - Polyester Wire Core #10	RHA-1350-WHT	\$72	\$63	RHA-1350-BZT	\$95	\$83
40'	5/16" - Polyester Wire Core #10	RHA-1400-WHT	\$80	\$73	RHA-1400-BZT	\$106	\$97



CAM CLEAT POLYESTER WIRE CORE ROPE ASSEMBLY

Wire Halyard

Concord American Flagpole offers a complete line of Wire Cable products for use with Internal Halyard systems. Each are constructed with Stainless Steel Wire Strand Aircraft Cable specifically chosen for its combination of high breaking strength, fatigue resistance, flexibility, and extreme corrosion resistance under the harshest exterior environments. Use with Internal Halyard Winch System Flagpoles only.



Flag Arrangements are constructed of stainless steel aircraft cable with two (2) copper crimps securing stainless steel yokes at each cable termination point. Two (2) Stainless Steel Flagsnaps, and two (2) Stainless Steel Connecting Links complete the assembly.

Flag Arrangement - Complete Assembly For Use With Wire Cable Based Internal Halyard Winch Systems

FLAG SIZE	FLAGSNAPS	PART NUMBER	1+	4+
2' X 3'	3-1/2" Stainless Steel (2)	FSA-0203	\$122	\$119
3' X 5'	3-1/2" Stainless Steel (2)	FSA-0305	\$132	\$122
4' X 6'	3-1/2" Stainless Steel (2)	FSA-0406	\$146	\$139
5' X 8'	3-1/2" Stainless Steel (2)	FSA-0508	\$150	\$143
6' X 10'	3-1/2" Stainless Steel (2)	FSA-0610	\$171	\$160

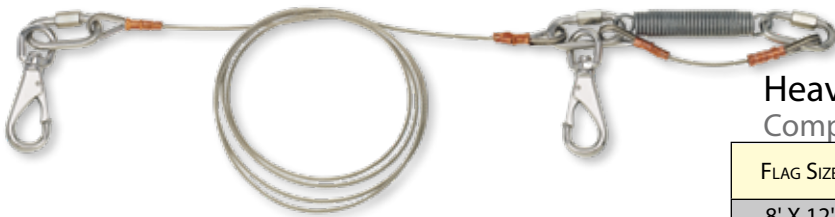

Heavy-Duty Flag Arrangements incorporate a Shock Spring Assembly into our standard Flag Arrangement. Containing a Shock Spring, Shock Spring Safety Cable and additional Stainless Steel Connecting Link, this heavy-duty design for larger flag sizes reduces the strain placed on both halyard components and flags.

Heavy-Duty Flag Arrangement Complete With Shock Spring Assembly

FLAG SIZE	FLAGSNAPS	PART NUMBER	1+	4+
8' X 12'	4-1/2" HD Stainless Steel (2)	FSA-0812	\$212	\$202
10' X 15'	4-1/2" HD Stainless Steel (2)	FSA-1015	\$223	\$212
12' X 18'	4-1/2" HD Stainless Steel (2)	FSA-1218	\$233	\$223
15' X 25'	4-1/2" HD Stainless Steel (2)	FSA-1525	\$240	\$226
20' X 30'	4-1/2" HD Stainless Steel (2)	FSA-2030	\$247	\$233
20' X 38'	4-1/2" HD Stainless Steel (2)	FSA-2038	\$247	\$233
30' X 50'	4-1/2" HD Stainless Steel (2)	FSA-3050	\$254	\$244
30' X 60'	4-1/2" HD Stainless Steel (2)	FSA-3060	\$254	\$244



The Shock Spring Assembly with Safety Cable contains a Shock Spring and Shock Spring Safety Cable. Use as a replacement Shock Spring Assembly for existing Heavy-Duty Flag Arrangements, or combine with an additional Stainless Steel Connecting Link (See Page 82) to turn any size Flag Arrangement into a Heavy-Duty design.

Shock Spring Assembly Shock Spring and Safety Cable For Use With Flag Arrangements

PART NUMBER	1+	4+
SPR-0100	\$42	\$39

MULTIPLE FLAG OPTIONS

To fly multiple flags on a single flagpole, order the desired Flag Arrangements and a Stainless Steel Connecting Link (See Page 82). It is recommended that an additional Retainer Ring Assembly be used at the junction of the two (2) Flag Arrangements.



Flag Arrangement - Leader Cable Only

For Use With Wire Cable Based Internal Halyard Winch Systems

FLAG SIZE	DESCRIPTIONS	PART NUMBER	1+	4+
2' X 3'	1/8" Stainless Steel Cable	FSA-0203-LC	\$22	\$21
3' X 5'	1/8" Stainless Steel Cable	FSA-0305-LC	\$24	\$22
4' X 6'	1/8" Stainless Steel Cable	FSA-0406-LC	\$27	\$26
5' X 8'	1/8" Stainless Steel Cable	FSA-0508-LC	\$31	\$29
6' X 10'	1/8" Stainless Steel Cable	FSA-0610-LC	\$33	\$32
8' X 12'	1/8" Stainless Steel Cable	FSA-0812-LC	\$35	\$33
10' X 15'	1/8" Stainless Steel Cable	FSA-1015-LC	\$39	\$37
12' X 18'	1/8" Stainless Steel Cable	FSA-1218-LC	\$44	\$40
15' X 25'	1/8" Stainless Steel Cable	FSA-1525-LC	\$49	\$46
20' X 30'	1/8" Stainless Steel Cable	FSA-2030-LC	\$79	\$73
20' X 38'	1/8" Stainless Steel Cable	FSA-2038-LC	\$79	\$73
30' X 50'	1/8" Stainless Steel Cable	FSA-3050-LC	\$103	\$98
30' X 60'	1/8" Stainless Steel Cable	FSA-3060-LC	\$103	\$98



Flag Arrangement Leader Cables are constructed of 1/8" stainless steel aircraft cable with two (2) copper crimps securing stainless steel yokes at each cable termination point. For use with existing Swivel, Flagsnaps and Connecting Links.

Wire Cable Assembly For Wire Cable Based Internal Halyard Winch System Flagpoles

FLAGPOLE HT.	DESCRIPTIONS	PART NUMBER	1+	4+
25'	1/8" Stainless Steel Wire Cable Assembly	WCA-0250	\$198	\$188
30'	1/8" Stainless Steel Wire Cable Assembly	WCA-0300	\$205	\$195
35'	1/8" Stainless Steel Wire Cable Assembly	WCA-0350	\$219	\$209
40'	1/8" Stainless Steel Wire Cable Assembly	WCA-0400	\$244	\$230
45'	1/8" Stainless Steel Wire Cable Assembly	WCA-0450	\$254	\$244
50'	1/8" Stainless Steel Wire Cable Assembly	WCA-0500	\$292	\$278
60'	1/8" Stainless Steel Wire Cable Assembly	WCA-0600	\$310	\$292
70'	1/8" Stainless Steel Wire Cable Assembly	WCA-0700	\$344	\$327
80'	1/8" Stainless Steel Wire Cable Assembly	WCA-0800	\$365	\$344
100'	SS Wire Cable (5/32" Lower - 1/8" Upper)	WCA-1000	\$504	\$476
120'	SS Wire Cable (5/32" Lower - 1/8" Upper)	WCA-1200	\$567	\$539
130'	SS Wire Cable (5/32" Lower - 1/8" Upper)	WCA-1300	\$629	\$598
140'	SS Wire Cable (5/32" Lower - 1/8" Upper)	WCA-1400	\$639	\$608
150'	SS Wire Cable (5/32" Lower - 1/8" Upper)	WCA-1500	\$702	\$667

Internal Halyard Cable Assemblies include a heavy-duty Stainless Steel Swivel which dramatically increases cable life by reducing stress on the halyard. Cable ends use stainless steel yokes which are attached with double heavy-duty copper crimps. Cable Assemblies are built upon our 1/8" SS Wire Cable and includes an attached Stop Sleeve for Winch attachment, two 1" Drilled Nylon Stop Balls, SS Yoke with two (2) heavy-duty Copper Crimps and Cable Swivel.



COMPLETE INTERNAL HALYARD WIRE CABLE ASSEMBLY

For a complete replacement of an Internal Halyard Winch System Assembly, order...

Wire Cable Assembly + Flag Arrangement (See Page 72) + Counterweight (See Page 75) + SS Connecting Link (See Page 82) + Retainer Ring Assembly (See Page 75)

Stainless Steel Wire Cable

For Wire Cable Based Internal Halyard Winch System Flagpoles

SIZE	DESCRIPTION	PART NUMBER	<500'	500'+	1,000'+
*Price per foot					
1/8"	Stainless Steel Wire Strand Cable (7x19)	HAL-0500	\$2.75	\$2.38	\$1.98
5/32"	Stainless Steel Wire Strand Cable (7x19)	HAL-0520	\$3.42	\$2.99	\$2.48



Flagsnaps

Flagsnaps are used in both Rope and Wire Halyard applications to attach the flag to the flagpole halyard. Nickle Plated Cast Zinc and Cast Brass are good options for the majority of applications, with Stainless Steel options providing superior strength and longevity. Heavy-duty Flagsnaps are preferable for larger flagpole options and in high wind zones. Nylon Snap Hooks are for residential applications only.



SNP-0200

Flagsnaps - Nickel Plated

DESCRIPTION	OVERALL LENGTH	PART NUMBER	12+	48+	96+	300+
Nickel Plated Cast Zinc	3-1/2"	SNP-0200	\$4.93	\$4.76	\$4.53	\$4.20



SNP-1000

SNP-1100

Flagsnaps - Cast Brass

DESCRIPTION	OVERALL LENGTH	PART NUMBER	12+	48+	96+	300+
Cast Brass	3"	SNP-1000	\$6.77	\$6.54	\$6.21	\$5.83
Cast Brass - Heavy-Duty	4-1/2"	SNP-1100	\$13.52	\$12.95	\$12.58	\$11.27



SNP-0700

SNP-0750

SNP-0350

Flagsnaps - Stainless Steel

DESCRIPTION	OVERALL LENGTH	PART NUMBER	12+	48+	96+	300+
Stainless Steel	3-1/2"	SNP-0700	\$26.24	\$25.23	\$23.89	\$21.88
Stainless Steel - Heavy-Duty	3-1/4"	SNP-0750	\$28.08	\$26.81	\$25.50	\$23.72
Stainless Steel - Heavy-Duty	4-1/2"	SNP-0350	\$34.66	\$32.82	\$31.00	\$27.34

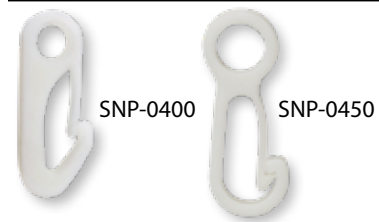

SNP-0400

SNP-0450

Flagsnaps - Cast Nylon For Residential Use Only

DESCRIPTION	OVERALL LENGTH	PART NUMBER	48+	96+	300+
Cast Nylon - Residential Use Only	2-3/8"	SNP-0400	\$1.31	\$1.27	\$1.18
Cast Nylon - Residential Use Only	2-3/4"	SNP-0450	\$1.51	\$1.47	\$1.36

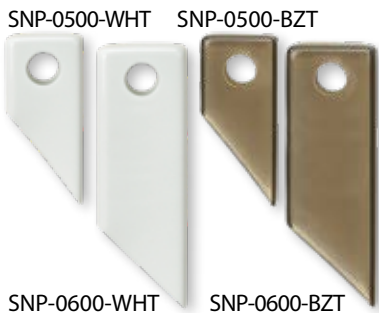

SNP-0500-WHT

SNP-0500-BZT

SNP-0600-WHT

SNP-0600-BZT

Flagsnap Covers

Neoprene Flagsnap Covers provide wear and shock protection combined with noise reduction.

USE WITH	PART NUMBER	12+	48+	96+	300+
WHITE					
3-1/2" Flagsnaps	SNP-0500-WHT	\$3.59	\$3.42	\$3.25	\$2.88
4-1/2" Flagsnaps	SNP-0600-WHT	\$6.08	\$5.73	\$5.57	\$5.20
BronzeTone					
3-1/2" Flagsnaps	SNP-0500-BZT	\$5.40	\$5.00	\$4.83	\$4.66
4-1/2" Flagsnaps	SNP-0600-BZT	\$6.27	\$5.90	\$5.73	\$5.40



Counterweight

Counterweights are required in Internal Halyard Systems to assist in the lowering of flags. They also ensure the flag hangs and flies properly in winds by keeping the flag taut. Three sizes allow the proper choice of counterweight based on wind zone and flag size flown.



The Industry's Only Patented Counterweight Patent #D594,380

Constructed of steel covered in a thick plastic coating, Concord American Flagpole's patented Counterweights are designed with heavy-duty, horizontal attaching bars. This design more efficiently distributes the stress load when compared to industry standard round-eye ends which concentrate the load in a single location. Dual attachment points in all sizes also provide a significantly increased safety level when compared to single attachment designs. This is the longest lasting, safest Counterweight the industry has to offer!

Counterweights

For Use With All Rope and Wire Internal Halyard Systems

WEIGHT	PART NUMBER	PART NUMBER	PART NUMBER	PART NUMBER	1+	6+	12+
	White	BronzeTone	Black	Silver			
3.5 LBS.	CWA-9100-WHT	CWA-9100-BZT	CWA-9100-BLK	CWA-9100-SIL	\$87	\$84	\$80
6.5 LBS.	CWA-9200-WHT	CWA-9200-BZT	CWA-9200-BLK	CWA-9200-SIL	\$112	\$108	\$105
14 LBS.	CWA-9300-WHT	CWA-9300-BZT	CWA-9300-BLK	CWA-9300-SIL	\$171	\$164	\$157

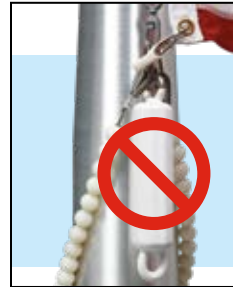

Safety Note:
The Retainer Ring and Rope Assembly or Flag Arrangement should never be attached to the same end of the Counterweight.

CWA-9100-WHT

CWA-9200-WHT

CWA-9300-WHT

Retainer Ring Assembly For Use with Internal or External Halyard Applications

Retainer Ring Assemblies are used to secure the bottom of the flag to the flagpole in Internal Halyard Systems. Additional Retainer Ring Assemblies are also recommended for multi-grommet flags used on larger Internal and External Halyard flagpoles, flags flown in higher wind areas and when flying multiple flags. All Retainer Rings are made using stainless steel cable with stainless steel yokes and two copper crimps at each end for an additional margin of safety. Crimps are machine compressed. The Heavy-Duty Retainer Rings use a combination of 2" diameter rollers and 1" diameter spacer balls for increased product life. Contact Customer Service for custom Retainer Ring Assemblies in sizes up to 72" flagpole butt diameter.



Retainer Ring Assemblies

BUTT DIA.	OVERALL LENGTH	CABLE SIZE	PART NUMBER	PART NUMBER	PART NUMBER	PART NUMBER	1+	6+	12+
			White	BronzeTone	Black	Silver			
4"	24"	1/8"	RRA-0004-WHT	RRA-0004-BZT	RRA-0004-BLK	RRA-0004-SIL	\$77	\$73	\$70
5"	28"	1/8"	RRA-0005-WHT	RRA-0005-BZT	RRA-0005-BLK	RRA-0005-SIL	\$80	\$77	\$73
6"	32"	1/8"	RRA-0006-WHT	RRA-0006-BZT	RRA-0006-BLK	RRA-0006-SIL	\$84	\$80	\$77
7"	36"	1/8"	RRA-0007-WHT	RRA-0007-BZT	RRA-0007-BLK	RRA-0007-SIL	\$91	\$87	\$84
8"	39"	1/8"	RRA-0008-WHT	RRA-0008-BZT	RRA-0008-BLK	RRA-0008-SIL	\$94	\$91	\$87
10"	46"	1/8"	RRA-0010-WHT	RRA-0010-BZT	RRA-0010-BLK	RRA-0010-SIL	\$108	\$105	\$101
12"	53"	1/8"	RRA-0012-WHT	RRA-0012-BZT	RRA-0012-BLK	RRA-0012-SIL	\$119	\$115	\$112



Heavy-Duty Retainer Ring Assemblies

BUTT DIA.	OVERALL LENGTH	CABLE SIZE	BALL DIA.	PART NUMBER	PART NUMBER	PART NUMBER	1+	6+	12+
				White	BronzeTone	Black			
8"	44"	5/32"	1" Ball / 2" Roller	RRA-0H08-WHT	RRA-0H08-BZT	RRA-0H08-BLK	\$153	\$146	\$141
10"	49"	5/32"	1" Ball / 2" Roller	RRA-0H10-WHT	RRA-0H10-BZT	RRA-0H10-BLK	\$165	\$159	\$152
12"	53"	5/32"	1" Ball / 2" Roller	RRA-0H12-WHT	RRA-0H12-BZT	RRA-0H12-BLK	\$197	\$188	\$181
14"	61"	5/32"	1" Ball / 2" Roller	RRA-0H14-WHT	RRA-0H14-BZT	RRA-0H14-BLK	\$212	\$204	\$195
16"	70"	5/32"	1" Ball / 2" Roller	RRA-0H16-WHT	RRA-0H16-BZT	RRA-0H16-BLK	\$245	\$233	\$224
18"	75"	5/32"	1" Ball / 2" Roller	RRA-0H18-WHT	RRA-0H18-BZT	RRA-0H18-BLK	\$277	\$264	\$254
20"	88"	5/32"	1" Ball / 2" Roller	RRA-0H20-WHT	RRA-0H20-BZT	RRA-0H20-BLK	\$301	\$289	\$278
22"	96"	5/32"	1" Ball / 2" Roller	RRA-0H22-WHT	RRA-0H22-BZT	RRA-0H22-BLK	\$329	\$317	\$303
24"	102"	5/32"	1" Ball / 2" Roller	RRA-0H24-WHT	RRA-0H24-BZT	RRA-0H24-BLK	\$363	\$349	\$337



Cleats

Cleats are used on External Halyard flagpoles as an anchoring location for the Rope Halyard.

*** - Specify Powder Coat Option
 BZT = Bronze Tone
 BLK = Black
 WHT = White
 CLR = Clear



Cast Aluminum Cleats

DESCRIPTION	MOUNTING BOLTS CENTER-TO-CENTER	PART NUMBER	6+	18+
		Satin		
6"	1-3/4"	CLA-9060	\$15.63	\$14.76
6" With Dealer Insert Area	1-3/4"	CLA-9065	\$19.12	\$18.25
9" Length	2-1/2"	CLA-9090	\$20.84	\$19.97
9" With Dealer Insert Area	2-1/2"	CLA-9095	\$22.57	\$21.70
		Powder Coat		
6"	1-3/4"	CLA-9060-***	\$22.57	\$21.70
6" With Dealer Insert Area	1-3/4"	CLA-9065-***	\$28.65	\$27.78
9" Length	2-1/2"	CLA-9090-***	\$30.21	\$27.78
9" With Dealer Insert Area	2-1/2"	CLA-9095-***	\$33.01	\$30.04



Plated Cleat for Sectional Flagpoles

For Use With Residential Flagpoles

DESCRIPTION	MOUNTING BOLTS CENTER-TO-CENTER	PART NUMBER	6+	18+
Plated Light-Duty Cleat	3/4"	CLA-9010	\$2.78	\$2.62

Cleat Mounting Adapter

The Cleat Mounting Adapter is designed for use on existing light poles. It can be permanently mounted with screws (provided) or mounted with hose clamps (by others) for damage-free or temporary Cleat mounting. For Side Mount Truck Kits incorporating the Cleat Mounting Adapter, see Page 69.



CLA-9900

*** - Specify Powder Coat Option
 BZT = Bronze Tone
 BLK = Black
 WHT = White
 CLR = Clear

Cleat Mounting Adapter

Use With 6" CLA-9060 Cleat

DESCRIPTION	MOUNTING BOLTS CENTER-TO-CENTER	PART NUMBER	6+	18+
		Satin		
Cleat Mounting Adapter	1-3/4"	CLA-9900	\$10.40	\$9.90
		Powder Coat		
Cleat Mounting Adapter	1-3/4"	CLA-9900-***	\$15.47	\$14.76



Halyard Security

Cleat Cover Assemblies, Halyard Cover Assemblies, and Halyard Security Kits (combining the Cleat and Halyard Covers) provide tamper resistant security for External Halyard flagpoles. Available in both Cylinder Lock and Padlock designs containing a sanded Satin finish that is complimentary to the flagpole, all are constructed of heavy, cast aluminum with stainless steel hinges. Cleat and stainless steel attaching screws are included, as well as keys for the Cylinder Lock models (Padlock by others). Installation utilizes the cleat holes. For replacement Cylinder Locks, see Page 78.

*** - Specify Powder Coat Option
 BZT = Bronze Tone
 BLK = Black
 WHT = White
 CLR = Clear

Cleat Cover - Cylinder Lock

USE WITH POLE DIAMETERS	DESCRIPTION	CLEAT SIZE	PART NUMBER	1+	6+
Satin					
3" to 4"	Cleat Cover - Cylinder Lock	6"	CCA-9040	\$205	\$198
5" to 6"	Cleat Cover - Cylinder Lock	9"	CCA-9030	\$264	\$251
7" to 12"	Cleat Cover - Cylinder Lock	9"	CCA-9020	\$372	\$355
Powder Coat					
3" to 4"	Cleat Cover - Cylinder Lock	6"	CCA-9040-***	\$240	\$226
5" to 6"	Cleat Cover - Cylinder Lock	9"	CCA-9030-***	\$299	\$285
7" to 12"	Cleat Cover - Cylinder Lock	9"	CCA-9020-***	\$407	\$389



Cleat Cover - Padlock

USE WITH POLE DIAMETERS	DESCRIPTION	CLEAT SIZE	PART NUMBER	1+	6+
Satin					
5" to 6"	Cleat Cover - Padlock	9"	CCA-8030	\$271	\$261
7" to 12"	Cleat Cover - Padlock	9"	CCA-8020	\$382	\$369
Powder Coat					
5" to 6"	Cleat Cover - Padlock	9"	CCA-8030-***	\$310	\$296
7" to 12"	Cleat Cover - Padlock	9"	CCA-8020-***	\$417	\$400



Halyard Cover Channel 5' Channel with Top Bracket

USE WITH POLE DIAMETERS	DESCRIPTION	PART NUMBER	1+	6+
Satin				
3" to 4"	Halyard Cover Channel	HBA-9040	\$195	\$185
5" to 6"	Halyard Cover Channel	HBA-9030	\$230	\$223
7" to 12"	Halyard Cover Channel	HBA-9020	\$266	\$257
Powder Coat				
3" to 4"	Halyard Cover Channel	HBA-9040-***	\$209	\$205
5" to 6"	Halyard Cover Channel	HBA-9030-***	\$247	\$240
7" to 12"	Halyard Cover Channel	HBA-9020-***	\$282	\$276

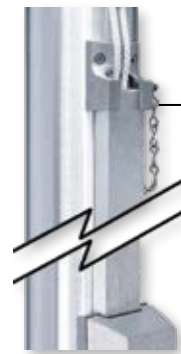

5' HALYARD COVER CHANNEL

BRACKET INCLUDES SAFETY CHAIN AND HARDWARE

SECURITY CLEAT COVER

Halyard Security Kit Cleat Cover, 5' Halyard Channel and Top Bracket

USE WITH POLE DIAMETERS	DESCRIPTION	USES CLEAT BOX / HALYARD CHANNEL	PART NUMBER	1+	6+
Satin					
3" to 4"	Halyard Security Kit - Cylinder Lock	CCA-9040 / HBA-9040	CHA-9200	\$400	\$382
5" to 6"	Halyard Security Kit - Cylinder Lock	CCA-9030 / HBA-9030	CHA-9000	\$494	\$473
7" to 12"	Halyard Security Kit - Cylinder Lock	CCA-9020 / HBA-9020	CHA-9050	\$556	\$535
5" to 6"	Halyard Security Kit - Padlock	CCA-8030 / HBA-9030	CHA-8000	\$494	\$473
7" to 12"	Halyard Security Kit - Padlock	CCA-8020 / HBA-9020	CHA-8050	\$556	\$535
Powder Coat					
3" to 4"	Halyard Security Kit - Cylinder Lock	CCA-9040-*** / HBA-9040-***	CHA-9200-***	\$448	\$435
5" to 6"	Halyard Security Kit - Cylinder Lock	CCA-9030-*** / HBA-9030-***	CHA-9000-***	\$546	\$525
7" to 12"	Halyard Security Kit - Cylinder Lock	CCA-9020-*** / HBA-9020-***	CHA-9050-***	\$629	\$605
5" to 6"	Halyard Security Kit - Padlock	CCA-8030-*** / HBA-9030-***	CHA-8000-***	\$546	\$525
7" to 12"	Halyard Security Kit - Padlock	CCA-8020-*** / HBA-9020-***	CHA-8050-***	\$629	\$605



Cam Cleats

Cam Cleats are used in Internal Rope Halyard Systems, securely holding the halyard behind a heavy-duty cam action cleat. Maximum Rope diameter is 5/16".

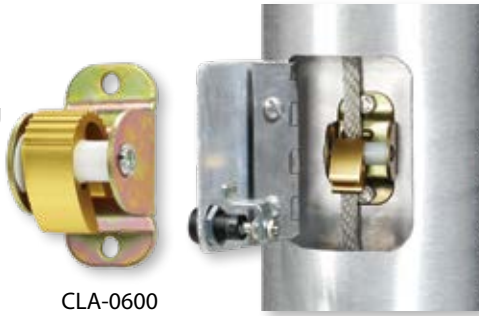

CLA-0600

Cam Cleats For Use With Rope Based Internal Halyard Systems

DESCRIPTION	MOUNTING BOLTS		
	CENTER-TO-CENTER	PART NUMBER	
Cam Cleat	2"	CLA-0600	1+ 6+ 18+

Winches

The Flagpole Winch provides a secure means of manually raising and lowering the flag in Internal Wire Cable Halyard flagpoles. Manufactured from stainless steel, this style of gearless winch was designed specifically for the flagpole industry, providing a smooth, easy method for raising, lowering, and stopping the flag at any height. The brake mechanism utilizes large bronze brake shoes which automatically engage when the handle stops rotating and is removed.

Winches For Use With Wire Based Internal Halyard Systems

DESCRIPTION	MOUNTING BOLTS		
	CENTER-TO-CENTER	PART NUMBER	
WINCH			1+ 6+ 18+
Small Winch - For Flagpoles Up To 45'	3-1/2"	WCH-0101	\$740 \$702 \$688
Large Winch - For Flagpoles 50' - 80'	3-1/2"	WCH-0201	\$766 \$737 \$723
Extra-Large Winch - Special Applications Only	*	WCH-0301	\$1,084 \$1,042 \$1,021
Winch Handle			
7/16" Handle for WCH-101, WCH-201, WCH-301	-	WCH-0401	\$53 \$49 \$42

*Four-Bolt Pattern - 3-1/2"h x 3-1/4"w



WCH-0101



WCH-0401



LOK-0100



LOK-0410



LOK-5645

LOK-6696

Cylinder Locks Replacement Locks for Doors in Internal Halyard Flagpoles

DESCRIPTION	PART NUMBER	1+	6+
INDEPENDENCE, SENTRY II, AND EXTREME XIRW FLAGPOLES			
CYLINDER DOOR LOCK WITH KEYS	LOK-0100	\$32	\$30
REPLACEMENT KEYS FOR LOK-0100	LOK-0410	\$19	\$17
SENTRY FLAGPOLES			
CYLINDER DOOR LOCK WITH KEYS	LOK-0100	\$32	\$30
REPLACEMENT KEYS FOR LOK-0300 PRODUCTS PRIOR TO 2021	LOK-0410	\$19	\$17
TITAN, MONARCH, AND EXTREME XIWW FLAGPOLES			
COMPRESSION DOOR LOCK WITH KEY - 5"-7" BUTT DIAMETERS	LOK-5645	\$66	\$63
COMPRESSION DOOR LOCK WITH KEY - 8"+ BUTT DIAMETERS	LOK-6696	\$70	\$66
REPLACEMENT KEY FOR LOK-5645 AND LOK-6696	LOK-5646	\$19	\$17



LOK-0100



LOK-5595

Cylinder Locks Replacement Locks for External Halyard Cylinder Lock Cleat Covers

DESCRIPTION	PART NUMBER	1+	6+
CLEAT COVERS CCA-9040, CCA-9030, AND CCA-9020 (SEE PAGE 77)			
CYLINDER DOOR LOCK WITH KEYS	LOK-0100	\$32	\$28
REPLACEMENT KEYS FOR LOK-0100	LOK-0410	\$19	\$17
CLEAT COVERS - AMERICAN FLAGPOLE PRODUCTS PRIOR TO 2018			
CYLINDER DOOR LOCK WITH KEYS	LOK-5595	\$32	\$28
REPLACEMENT KEYS FOR LOK-5595	LOK-0410	\$19	\$17

Ground Sleeves - Steel

Corrugated Steel with Steel Lightning Spike Two-Piece Design

Corrugated Steel Ground Sleeves with Steel Lightning Spike are designed for use in Ground Set flagpole installations (See Page 14). Our superior 2-piece design contains an upper section manufactured of galvanized 16-gauge corrugated steel tube, a thick steel base plate, and steel centering wedges welded into the base to assist in plumb installations of the flagpole. The lower section incorporates a threaded top 3/4" diameter steel grounding spike with 6" x 6" steel setting plate, allowing the concrete foundation to completely surround the sleeve. Contact Customer Service for custom sizes, larger sizes, or special applications.

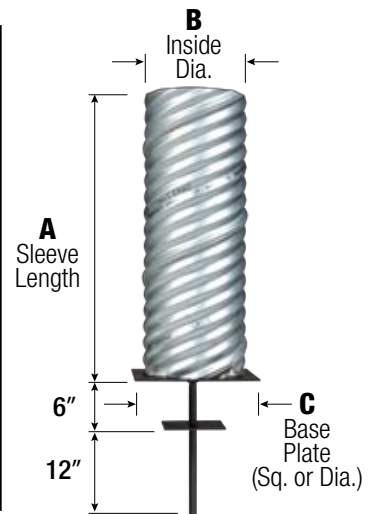

Flagpole Height	"A" Sleeve Length	Part Number	1+	Part Number	1+	Part Number	1+	Part Number	1+	Part Number	1+
		4" Butt Diameter Flagpoles		5" Butt Diameter Flagpoles		6-7" Butt Diameter Flagpoles		8" Butt Diameter Flagpoles		10-12" Butt Diameter Flagpoles	
		Sleeve Dia. "B"= 6" Base Plate "C" = 8"		Sleeve Dia. "B"= 8" Base Plate "C" = 10"		Sleeve Dia. "B"= 10" Base Plate "C" = 12"		Sleeve Dia. "B"= 12" Base Plate "C" = 14"		Sleeve Dia. "B"= 15" Base Plate "C" = 16"	
20'	2'	GCA-2006	\$297	GCA-2008	\$316	GCA-2010	\$322				
25'	2'-6"	GCA-2506	\$316	GCA-2508	\$326	GCA-2510	\$336				
30'	3'	GCA-3006	\$324	GCA-3008	\$334	GCA-3010	\$344	GCA-3012	\$382		
35'	3'-6"			GCA-3508	\$346	GCA-3510	\$355	GCA-3512	\$400		
40'	4'			GCA-4008	\$353	GCA-4010	\$393	GCA-4012	\$442	GCA-4015	\$487
45'	4'-6"					GCA-4510	\$417	GCA-4512	\$480	GCA-4515	\$504
50'	5'					GCA-5010	\$435	GCA-5012	\$518	GCA-5015	\$575
55'	5'-6"									GCA-5515	\$608
60'	6'									GCA-6015	\$639
65'	6'-6"									GCA-6515	\$695
70'	7'									GCA-7015	\$758
75'	7'-6"									GCA-7515	\$782
80'	8'									GCA-8015	\$848

Ground Sleeves – PVC

PVC Ground Sleeves aid in the proper Ground Set installation of smaller residential and commercial flagpoles. They are not recommended for use on installations exceeding 35', flagpoles having larger wall thicknesses, flagpoles located in high wind regions, or in flagpoles applications flying oversized or multiple flags. See Page 14, *Ground Set Foundations*, for more information.



Flagpole Height	"A" Sleeve Length	Part Number	1+	Part Number	1+	Part Number	1+	Part Number	1+
		2" Butt Diameter Flagpoles		2-1/2 - 3" Butt Diameter Flagpoles		4" Butt Diameter Flagpoles		5" Butt Diameter Flagpoles	
		Sleeve Inner Diameter 2" Nominal		Sleeve Inner Diameter 4" Nominal		Sleeve Inner Diameter 6" Nominal		Sleeve Inner Diameter 8" Nominal	
15'	1'-6"			GST-1504	\$28				
20'	2'	GST-2002	\$16	GST-2004	\$30	GST-2006	\$56	GST-2008	\$79
25'	2'-6"			GST-2504	\$32	GST-2506	\$68	GST-2508	\$87
30'	3'					GST-3006	\$80	GST-3008	\$96
35'	3'-6"							GST-3508	\$105

Lightning Rod Kit

Lightning Rod Kits are constructed of 7-strand, 1/2" diameter x 6' long aluminum cable and 5/8" diameter x 5' long copper clad rod. Self tapping screw, assembly hardware and installation instructions for field installation.

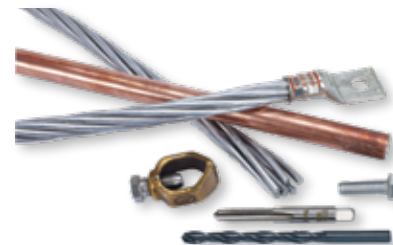

DESCRIPTION	PART NUMBER	1+	6+
Lightning Rod Kit	LRK-9019	\$326	\$308



Spun Collars

Our most common style flash collar, Spun Aluminum Collars are manufactured to exacting specifications from the highest quality materials. They provide the perfect finishing touch for both Ground Set and Shoe Base installations. Split, two-piece collars are available for replacing or adding a collar to existing flagpoles. I.D. approximately 1/8" wider than Butt Diameter.

*** - Specify Finish
 BZT = Bronze Tone Powder Coat
 BLK = Black Powder Coat
 WHT = White Powder Coat



All Spun and Cast Collars are Available in Both 1-Piece and 2-Piece Designs



STYLE A - FC11
 SPUN ALUMINUM

.080" Thickness - 33%
 Stronger Than Standard
 Competitor's Products

STYLE A - FC11 - Spun Aluminum 1-Piece Construction

BUTT DIA.	OUTSIDE DIA.	PART NUMBER	1+	6+	12+	PART NUMBER	1+	6+	12+
Satin						Powder Coat			
2"	12"	COL1-A02S	\$60	\$58	\$54	COL1-A02S-***	\$80	\$79	\$77
2-1/2"	12"	COL1-A25S	\$60	\$58	\$54	COL1-A25S-***	\$80	\$79	\$77
3"	12"	COL1-A03S	\$60	\$58	\$54	COL1-A03S-***	\$80	\$79	\$77
3-1/2"	12"	COL1-A35S	\$60	\$58	\$54	COL1-A35S-***	\$80	\$79	\$77
4"	12"	COL1-A04S	\$60	\$58	\$54	COL1-A04S-***	\$80	\$79	\$77
5"	14"	COL1-A05S	\$63	\$61	\$58	COL1-A05S-***	\$86	\$84	\$80
6"	14"	COL1-A06S	\$63	\$61	\$58	COL1-A06S-***	\$86	\$84	\$80
7"	14"	COL1-A07S	\$63	\$61	\$58	COL1-A07S-***	\$86	\$84	\$80
8"	18"	COL1-A08S	\$103	\$99	\$96	COL1-A08S-***	\$134	\$131	\$127
10"	18"	COL1-A10S	\$103	\$99	\$96	COL1-A10S-***	\$134	\$131	\$127
12"	18"	COL1-A12S	\$103	\$99	\$96	COL1-A12S-***	\$134	\$131	\$127

Add \$93 for a Split 2-Piece version of the Style A - FC11 Spun Aluminum Collar.
 Modify Part # COL1 to COL2 (Example Part #: COL2-A02S).



STYLE B
 SPUN ALUMINUM

For Use With Shoe
 Base Flagpole
 Applications



STYLE B - Spun Aluminum 1-Piece Construction

BUTT DIA.	OUTSIDE DIA.	PART NUMBER	1+	6+	12+	PART NUMBER	1+	6+	12+
Satin						Powder Coat			
4"	9-7/8"	COL1-B04S	\$119	\$113	\$110	COL1-B04S-***	\$160	\$152	\$146
5"	9-7/8"	COL1-B05S	\$126	\$119	\$117	COL1-B05S-***	\$169	\$160	\$155
6"	13"	COL1-B06S	\$131	\$124	\$122	COL1-B06S-***	\$176	\$167	\$162
7"	14-1/8"	COL1-B07S	\$132	\$126	\$124	COL1-B07S-***	\$179	\$169	\$164
8"	15-1/16"	COL1-B08S	\$136	\$129	\$127	COL1-B08S-***	\$183	\$174	\$169
10"	18-1/8"	COL1-B10S	\$183	\$174	\$171	COL1-B10S-***	\$247	\$235	\$226
12"	22-5/8"	COL1-B12S	\$327	\$312	\$306	COL1-B12S-***	\$391	\$380	\$371

Add \$121 for a Split 2-Piece version of the Style B Spun Aluminum Collar.
 Modify Part # COL1 to COL2 (Example Part #: COL2-B04S).

Cast Collars

Our offering of heavy-duty Cast Aluminum Collars provide project owners the strongest and most durable collar offered in the industry today! Cast from Aluminum Alloy, these 1/4" thick cast collars are designed to withstand the harshest of environments. Offered in both 1-piece and 2-piece designs, they are perfect as either an upgrade to a new flagpole purchase or as a replacement or addition to an existing flagpole. *I.D. approximately 1/8" wider than Butt Diameter.*



STYLE A - FC11 - Cast Aluminum 1-Piece Construction

BUTT DIA.	OUTSIDE DIA.	PART NUMBER	1+	6+	12+	PART NUMBER	1+	6+	12+
		Satin				Powder Coat			
3"	14"	COL1-A03C	\$170	\$162	\$159	COL1-A03C-***	\$211	\$204	\$193
3-1/2"	14"	COL1-A35C	\$170	\$162	\$159	COL1-A35C-***	\$211	\$204	\$193
4"	14"	COL1-A04C	\$170	\$162	\$159	COL1-A04C-***	\$211	\$204	\$193
5"	14"	COL1-A05C	\$170	\$162	\$159	COL1-A05C-***	\$211	\$204	\$193
6"	14"	COL1-A06C	\$170	\$162	\$159	COL1-A06C-***	\$211	\$204	\$193
7"	14"	COL1-A07C	\$170	\$162	\$159	COL1-A07C-***	\$211	\$204	\$193
8"	18"	COL1-A08C	\$384	\$365	\$358	COL1-A08C-***	\$487	\$462	\$448
10"	18"	COL1-A10C	\$384	\$365	\$358	COL1-A10C-***	\$487	\$462	\$448
12"	18"	COL1-A12C	\$384	\$365	\$358	COL1-A12C-***	\$487	\$462	\$448

*** - Specify Finish
 BZT = Bronze Tone Powder Coat
 BLK = Black Powder Coat
 WHT = White Powder Coat



STYLE A - FC11
CAST ALUMINUM

Add \$76 for a Hidden Bolt, Split 2-Piece version of the Style A - FC11 Cast Collar.
 Modify Part # COL1 to COL2 (Example Part #: COL2-A03C).

STYLE C - FC15 - Cast Aluminum 1-Piece Construction

BUTT DIA.	OUTSIDE DIA.	PART NUMBER	1+	6+	12+	PART NUMBER	1+	6+	12+
		Satin				Powder Coat			
5"	20"	COL1-C05C	\$811	\$771	\$747	COL1-C05C-***	\$884	\$841	\$815
6"	20"	COL1-C06C	\$811	\$771	\$747	COL1-C06C-***	\$884	\$841	\$815
7"	20"	COL1-C07C	\$811	\$771	\$747	COL1-C07C-***	\$884	\$841	\$815
8"	20"	COL1-C08C	\$811	\$771	\$747	COL1-C08C-***	\$884	\$841	\$815
10"	24"	COL1-C10C	\$1,041	\$988	\$957	COL1-C10C-***	\$1,094	\$1,041	\$1,008
12"	24"	COL1-C12C	\$1,041	\$988	\$957	COL1-C12C-***	\$1,094	\$1,041	\$1,008



STYLE C - FC15
CAST ALUMINUM

Add \$121 for a Hidden Bolt, Split 2-Piece version of the Style C - FC15 Cast Collar.
 Modify Part # COL1 to COL2 (Example Part #: COL2-C05C).



LNK-0300

Connecting Link 5/16" Thread-Lock Stainless Steel

DESCRIPTION	PART NUMBER	6+	12+
Connecting Link - Stainless Steel	LNK-0300	\$17.38	\$16.23



YOK-0014
YOK-0516

Cable Yoke Stainless Steel

DESCRIPTION	PART NUMBER	12+	36+
Yoke - Stainless Steel - 1/4"	YOK-0014	\$3.99	\$3.82
Yoke - Stainless Steel - 5/16"	YOK-0516	\$5.80	\$5.57



CRP-0100 CRP-0250 CRP-0500 CRP-0520

Crimps Cable and Rope

DESCRIPTION	PART NUMBER	25+	100+
1/8" Cable Crimp - Copper	CRP-0100	\$1.22	\$1.18
5/32" Cable Crimp - Copper	CRP-0250	\$1.60	\$1.54
5/16" Rope Crimp - Aluminum	CRP-0500	\$2.74	\$2.58
3/8" Rope Crimp - Aluminum	CRP-0520	\$3.66	\$3.49



CRP-0200 CRP-0800

Cable Stop For Use With Wire Cable Winch Systems

DESCRIPTION	PART NUMBER	6+	12+
1/8" Cable Stop Crimp - Copper	CRP-0200	\$1.48	\$1.41
5/32" Cable Stop Crimp - Copper	CRP-0800	\$2.55	\$2.45

Retainer Ring Balls

DESCRIPTION	PART NUMBER	50+	100+	300+
White				
1" White Nylon Ball - Drilled	RRB-1000-WHT	\$1.31	\$1.15	\$1.04
BronzeTone				
1" Bronzestone Nylon Ball - Drilled	RRB-1000-BZT	\$1.31	\$1.15	\$1.04
Black				
1" Black Nylon Ball - Drilled	RRB-1000-BLK	\$1.38	\$1.22	\$1.11
Silver				
1" Silver Nylon Ball - Drilled	RRB-1000-SIL	\$1.38	\$1.22	\$1.11



Cable Swivel Stainless Steel



SWL-0100

DESCRIPTION	PART NUMBER	6+	12+
Cable Swivel - Stainless Steel	SWL-0100	\$23.79	\$22.05

Snap Hook Assembly

The Snap Hook Assembly consists of 1/8" stainless steel wire cable, Stop Sleeves (attached to each end), Wire Clamp and Stainless Steel Snap Hook. This Assembly is used to attach large, multi-grommeted flags or when flying multiple flags. Use with Wire Cable Winch Systems only.



SHA-9451

Snap Hook Assembly For Use With Wire Cable Winch Systems

DESCRIPTION	PART NUMBER	6+	12+
Snap Hook Assembly	SHA-9451	\$22.57	\$20.84

Wire Halyard Clamp



RWC-9027

DESCRIPTION	PART NUMBER	6+	12+
Rope Wire Clamp	RWC-9027	\$1.68	\$1.64



Screws and Drill & Tap Set

Stainless Steel Screws are designed for use with both Cast Cleats (See Page 76) and Flagpole Top Adaptors (See Page 64). Drill and Tap Kit contains bit and 5/16"-18NC Tap.

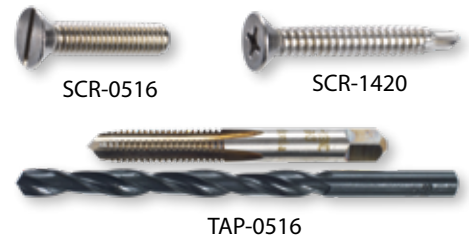

DESCRIPTION	PART NUMBER	1+	6+	12+
Stainless Steel 1-1/2" Cleat Screw - 5/16"-18NC	SCR-0516	\$0.90	\$0.74	\$0.70
SS 2" Self Tapping Cleat Screw - 1/4"-20NC	SCR-1420	\$1.74	\$1.65	\$1.58
Drill & Tap - 5/16"-18NC	TAP-0516	\$23.45	\$21.70	\$19.97

Wall Anchorage For Use With Outrigger and Vertical Wall Mount Flagpole Systems*

The Wall Anchorage Kit consists of a 3/4"-10NC x 18" Stainless Steel through bolt, 3/4" Stainless Steel Nuts, Spring Lock Washers, Flat Lock Washers, and 1-1/4" x 14" Schedule 10 Aluminum pipe. Each Kit contains one (1) bolt.

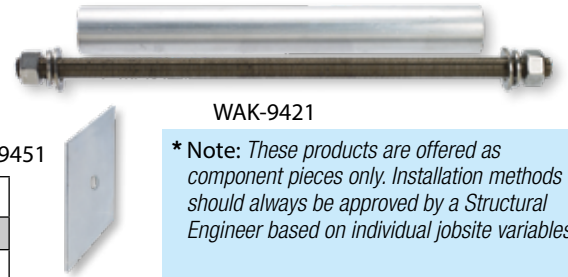

DESCRIPTION	PART NUMBER	1+	6+	12+
Wall Anchorage Kit - 3/4" Dia. Through Bolt	WAK-9421	\$93.76	\$85.08	\$83.34
4" x 4" Backing Plate - 7/8" Dia. Hole	WAK-9451	\$19.10	\$17.36	\$15.63

*** Note:** These products are offered as component pieces only. Installation methods should always be approved by a Structural Engineer based on individual jobsite variables.

Outrigger Retainer Kit

The Outrigger Retainer Kit allows the tension on the halyard to be relieved, facilitating both the raising and lowering of the flag while providing a way to unfurl a flag wrapped around an Outrigger Wall Mount Shaft. The system is offered as a complete kit containing the Pulley Block, TRK-0030, 75' HAL-0710-WHT Halyard, CLA-9090 9" Cleat, YOK-0014 Stainless Steel Yoke, CRP-0500 Aluminum Crimp, and LNK-0300 Connecting Link.



DESCRIPTION	PART NUMBER	1+	6+	12+
Outrigger Retainer Kit	ORK-1000	\$104.18	\$95.50	\$93.76

Pulleys / Eyebolt Single and Double Swivel

Pulleys are constructed of zinc-plated housings, nylon pulleys and brass connecting pins. Eyebolt is 3/8"-16NC x 3-1/4" Long Stainless Steel.

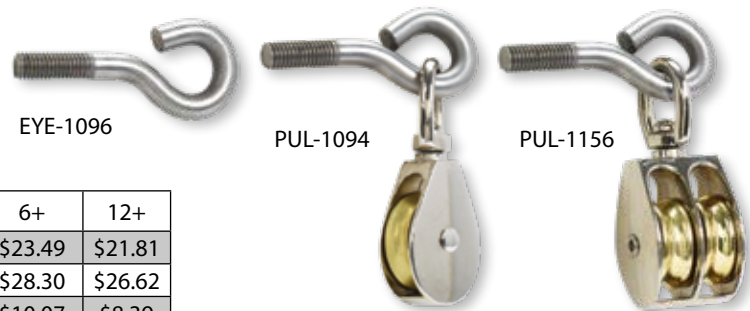

DESCRIPTION	PART NUMBER	1+	6+	12+
Single Pulley - With Swivel and Eyebolt	PUL-1094	\$25.16	\$23.49	\$21.81
Double Pulley - With Swivel and Eyebolt	PUL-1156	\$29.98	\$28.30	\$26.62
Eyebolt - 3/8"	EYE-1096	\$11.74	\$10.07	\$8.39

Touch Up Paint Specify Color

Touch-Up Paints from Concord American Flagpole contain the highest quality spray paint custom matched to our most popular Powder Coat colors.

*** - Specify Powder Coat Option
 BZT = Bronze Tone WHT = White
 BLK = Black



DESCRIPTION	PART NUMBER	1+	6+	12+
Touch Up Paint - 12 oz. Aerosol Can - Standard Colors	PNT-7907-***	\$29.19	\$28.35	\$27.51

POLELED



PROFESSIONAL FLAGPOLE LIGHT



HOW IT WORKS

- CREE LEDs create a clear and uniform light distribution
- PoleLED light units can be used on almost every type of existing and new poles. Including: Aluminum, wood, fiberglass, or steel
- Made of Aluminum
- Patented and developed focusing on sustainability and energy efficiency.
- Available in 3 sizes and any color to match your pole

MORE VISIBILITY

The PoleLED O2, Extended, and Basic uplights contain LEDs arranged in a circular unit. Giving off light from every angle ensuring that your flag is fully illuminated at all times.



PoleLED – Uplight Series

This unique system consists of a ring of powerful LEDs comprised in a circular unit that installs around the flagpole. With this patented design, PoleLED provides 360 degrees of illumination, distributing bright light uniformly to ensure your flag is always in view. Regardless of windspeed and direction, your flag is always lit from its best angle. No more shadows or need for expensive concrete poured foundations. The PoleLED provides a versatile flag lighting option that operates safely with any style of flagpole.

- 360 Degrees of Illumination
- CREE LEDs Lights Rated for 50,000+ Hours
- 3 Color Temperature Options (3K, 4K, 5K)
- Can be used on every type of existing and new poles

Including: Aluminum, wood, fiberglass, or steel

- 24 Volt System includes an Outdoor Rated Driver
- Design Allows for Retrofit Installations
- Meets U.S. Code Section 4 & 6 requirements for the flag



PoleLED Mounting Height Guide



Learn more about PoleLED & the Halyard System



Halyard Kit Add On

*** - Specify Finish Option

- CLR = Clear/Satin
- BLK = Black
- WHT = White

- Specify Lighting

- Color Temperature
- 3K = 3000 (Kelvin)
- 4K = 4000 (Kelvin)
- 5K = 5000 (Kelvin)

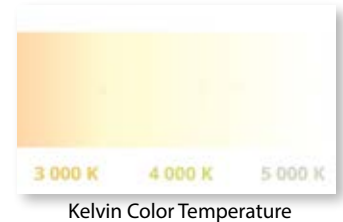

Kelvin Color Temperature

PoleLED - Basic Light

With or Without Halyard Kit - 12 LED's

FLAGPOLE MAX BUTT DIA.	DESCRIPTION	LUMENS	WATTS	CABLE LENGTH	SIZE	PART NUMBER	1+
4"	PoleLED Basic	2300	24	23'	9.1x7.1"	PLED-4##-O-***	\$1,200
4"	PoleLED Basic w/Halyard Kit	2300	24	23'	9.1x7.1"	PLED-4##-H-***	\$1,470

Example Part #: PLED-43K-H-BLK
 PoleLED Basic Light, 4" Max Butt Diameter, 3K Lighting Color Temperature, with Halyard Kit and Black Finish

= Specify Color Temp (3K, 4K, 5K)
 *** = Specify Finish Option



PoleLED - Extended Light

With or Without Halyard Kit - 10 LED's

FLAGPOLE MAX BUTT DIA.	DESCRIPTION	LUMENS	WATTS	CABLE LENGTH	SIZE	PART NUMBER	1+
5"	PoleLED Extended	3250	38	33'	10.2x8.3"	PLED-5##-O-***	\$2,700
5"	PoleLED Extended w/Halyard Kit	3250	38	33'	10.2x8.3"	PLED-5##-H-***	\$2,970

Example Part #: PLED-53K-H-BLK
 PoleLED Extended Light, 5" Max Butt Diameter, 3K Lighting Color Temperature, with Halyard Kit and Black Finish

= Specify Color Temp (3K, 4K, 5K)
 *** = Specify Finish Option



PoleLED - O2 Light

With or Without Halyard Kit - 28 LED's

FLAGPOLE MAX BUTT DIA.	DESCRIPTION	LUMENS	WATTS	CABLE LENGTH	SIZE	PART NUMBER	1+
9"	PoleLED O2	9500	90	33'	14x12.5"	PLED-9##-O-***	\$3,700
9"	PoleLED O2 w/Halyard Kit	9500	90	33'	14x12.5"	PLED-9##-H-***	\$3,970

Example Part #: PLED-93K-H-BLK
 PoleLED O2 Light, 9" Max Butt Diameter, 3K Lighting Color Temperature, with Halyard Kit and Black Finish

= Specify Color Temp (3K, 4K, 5K)
 *** = Specify Finish Option



Official U.S. Flag Code - Section 2

A. "...when a patriotic effect is desired, the flag may be displayed twenty-four hours a day if properly illuminated during the hours of darkness."



American Beacon – Internal Halyard Series

The American Beacon Internal Halyard Series provides lighting options for both Winch and Cam Cleat flagpoles systems in heights from 20' – 80'. These options provide the most environmentally correct way for flagpole illumination, properly lighting the flag during nighttime hours without lighting adjoining properties and the night sky!

- Internal Halyard 359° Revolving Truck
- 12 Volt System With Driver Contained Inside the Truck
- Warm White, 3000K LED Lights Rated for 25,000+ Hours
- 110V / 120V Input, 12 Volt Output
- Wire Provided For Flagpole Height Plus 10' (Flagpole Height To Be Provided in Part #)
- Standard 1-1/4" NPT Spindle
- Solar Options Available
- Standard 1/2"-13NC Top Drilling on Dual and Quad Internal Winch Models (5/8"-11NC Available Upon Request)

Patent #7,275,495

*** - Specify Finish Option
 SAT = Satin
 BZT = BronzeTone Powder Coat
 BLK = Black Powder Coat
 WHT = White Powder Coat



IDA Approved Dark-Sky Friendly Fixture

Internal Halyard Beacon - Dual Light Winch System - Wire Halyard

FLAGPOLE MAX TOP DIA.	DESCRIPTION	TOTAL LUMENS	BEACON SIZE	PART NUMBER	1+ SATIN	1+ POWDER
Beacon						
3.5"	BEACON - Dual Light	500	6" Dia.	ABW2-##FS-***	\$4,091	\$4,206
4"	BEACON - Dual Light	500	8" Dia.	ABW2-##4S-***	\$5,227	\$5,342
Beacon Plus						
3.5"	BEACON PLUS - Dual	572	6" Dia.	ABW2-##FP-***	\$4,634	\$4,749
4"	BEACON PLUS - Dual	572	8" Dia.	ABW2-##4P-***	\$5,227	\$5,342



Beacon Plus - Dual Light
 Illuminate the flag while at rest! The Internal Halyard, Dual Light Beacon Plus incorporates two vertical 2 Watt MR16 LED bulbs.

Example Part #: ABW2-30FS-SAT
 American Beacon Internal Halyard Dual Light, 30' Flagpole, 3.5" Max Top Flagpole Diameter, Standard Beacon, Satin Finish
 ## = Specify Flagpole Height (20, 25, 30 etc.)
 *** = Specify Finish Option

Internal Halyard Beacon - Quad Light Winch System - Wire Halyard

FLAGPOLE MAX TOP DIA.	DESCRIPTION	TOTAL LUMENS	BEACON SIZE	PART NUMBER	1+ SATIN	1+ POWDER
Beacon						
4"	BEACON - Quad Light	1000	8" Dia.	ABW4-##4S-***	\$5,380	\$5,495
Beacon Plus						
4"	BEACON PLUS - Quad	1072	8" Dia.	ABW4-##4P-***	\$5,999	\$6,114



Beacon Plus - Quad Light
 Illuminate the flag while at rest! The Internal Halyard, Quad Light Beacon Plus incorporates two vertical 2 Watt MR16 LED bulbs.

Example Part #: ABW4-604P-BZT
 American Beacon Internal Halyard Quad Light, 60' Flagpole, 4" Max Top Flagpole Diameter, Beacon Plus, BronzeTone Powder Coat Finish
 ## = Specify Flagpole Height (20, 25, 30 etc.)
 *** = Specify Finish Option

Internal Halyard Cam Cleat Beacon

- 8" Gold or Silver Anodized Ball Only
- Accepts up to 5/16" Rope Halyard

FLAGPOLE MAX TOP DIA.	BALL COLOR	DESCRIPTION	TOTAL LUMENS	BEACON SIZE	PART NUMBER	1+ SATIN	1+ POWDER
Beacon							
3"	Gold	Cam Cleat BEACON	500	8" Dia.	ABCC-##3S-GLD-***	\$3,582	\$3,697
3.5"	Gold	Cam Cleat BEACON	500	8" Dia.	ABCC-##FS-GLD-***	\$3,660	\$3,775
4"	Gold	Cam Cleat BEACON	500	8" Dia.	ABCC-##4S-GLD-***	\$4,508	\$4,551
3"	Silver	Cam Cleat BEACON	500	8" Dia.	ABCC-##3S-SIL-***	\$3,582	\$3,697
3.5"	Silver	Cam Cleat BEACON	500	8" Dia.	ABCC-##FS-SIL-***	\$3,660	\$3,775
4"	Silver	Cam Cleat BEACON	500	8" Dia.	ABCC-##4S-SIL-***	\$4,508	\$4,623
Beacon Plus							
3"	Gold	Cam Cleat BEACON PLUS	572	8" Dia.	ABCC-##3P-GLD-***	\$4,160	\$4,275
3.5"	Gold	Cam Cleat BEACON PLUS	572	8" Dia.	ABCC-##FP-GLD-***	\$4,203	\$4,318
4"	Gold	Cam Cleat BEACON PLUS	572	8" Dia.	ABCC-##4P-GLD-***	\$5,128	\$5,243
3"	Silver	Cam Cleat BEACON PLUS	572	8" Dia.	ABCC-##3P-SIL-***	\$4,172	\$4,286
3.5"	Silver	Cam Cleat BEACON PLUS	572	8" Dia.	ABCC-##FP-SIL-***	\$4,203	\$4,318
4"	Silver	Cam Cleat BEACON PLUS	572	8" Dia.	ABCC-##4P-SIL-***	\$5,128	\$5,243



Beacon Plus - Internal Cam Cleat
 Illuminate the flag while at rest! The Internal Halyard Beacon Plus incorporates two vertical 2 Watt MR8 bulbs.

Example Part #: ABCC-25FS-GLD-BLK American Beacon Internal Halyard Cam Cleat, 25' Flagpole, 3.5" Max Top Flagpole Diameter, Standard Beacon, Gold Anodized Ball, Black Powder Coat Finish
 ## = Specify Flagpole Height (20, 25, 30 etc.)
 *** = Specify Finish Option
 (Specified Finishes Applied to Truck Only.)



American Beacon – External Halyard Series

The American Beacon External Halyard Series provide lighting options for flagpole systems in heights from 20' – 50'. These options provide the most environmentally correct way for flagpole illumination, properly lighting the flag during nighttime hours without lighting adjoining properties and the night sky!

- External Halyard 359° Revolving Truck
- 12 Volt System With Driver Contained Inside the Ball
- Warm White, 3000K LED Lights Rated for 25,000+ Hours
- 110V / 120V Input, 12 Volt Output
- Wire Provided For Flagpole Height Plus 10' (Flagpole Height To Be Provided in Part #)
- Standard, 1-1/4" NPT Spindle
- Solar Options Available
- Double Truck Systems are NOT Available

Patent #7,275,495

*** - Specify Finish Option
 SAT = Satin
 BZT = BronzeTone Powder Coat
 BLK = Black Powder Coat
 WHT = White Powder Coat



External Halyard Beacon - Standard Rope Halyard - Revolving - Spindle Truck

FLAGPOLE TOP DIA.	BALL COLOR	DESCRIPTION	TOTAL LUMENS	BEACON DIA.	PART NUMBER	1+ SATIN	1+ POWDERCOAT
Beacon							
3.5"	Gold	External Halyard BEACON - Standard	500	8"	ABES-##FS-GLD-***	\$2,021	\$2,136
3.5"	Silver	External Halyard BEACON - Standard	500	8"	ABES-##FS-SIL-***	\$2,039	\$2,154
Beacon Plus							
3.5"	Gold	Ext. Halyard BEACON PLUS - Standard	572	8"	ABES-##FP-GLD-***	\$2,660	\$2,775
3.5"	Silver	Ext. Halyard BEACON PLUS - Standard	572	8"	ABES-##FP-SIL-***	\$2,660	\$2,775



Beacon Plus - Standard External Halyard
 Illuminate the flag while at rest!
 The Standard External Halyard Beacon Plus incorporates two vertical 2 Watt MR8 bulbs.

Example Part #: ABES-30FS-GLD-SAT
 American Beacon External Halyard (Standard), 30' Flagpole, 3.5" Max Top Flagpole Diameter, Standard Beacon, Gold Anodized Ball, Satin Finish

= Specify Flagpole Height (20, 25, 30 etc.)
 *** = Specify Finish Option
 (Specified Finishes Applied to Truck Only.)



External Halyard Beacon - Heavy-Duty Rope Halyard - Revolving - Spindle Truck

FLAGPOLE TOP DIA.	BALL COLOR	DESCRIPTION	TOTAL LUMENS	BEACON SIZE	PART NUMBER	1+ SATIN	1+ POWDERCOAT
Beacon							
5"	Gold	Ext. Halyard BEACON - Heavy-Duty	500	8" Dia.	ABEH-##5S-GLD-***	\$3,370	\$3,485
5"	Silver	Ext. Halyard BEACON - Heavy-Duty	500	8" Dia.	ABEH-##5S-SIL-***	\$3,370	\$3,485
Beacon Plus							
5"	Gold	Ext. Halyard BEACON PLUS - Heavy-Duty	572	8" Dia.	ABEH-##5P-GLD-***	\$3,987	\$4,102
5"	Silver	Ext. Halyard BEACON PLUS - Heavy-Duty	572	8" Dia.	ABEH-##5P-SIL-***	\$3,987	\$4,102



Beacon Plus - Heavy-Duty External Halyard
 Illuminate the flag while at rest!
 The Heavy-Duty External Halyard Beacon Plus incorporates two vertical 2 Watt MR8 bulbs.

Example Part #: ABEH-505P-SIL-BZT
 American Beacon Heavy-Duty External Halyard, 50' Flagpole, 5" Max Top Flagpole Diameter, Beacon Plus, Silver Anodized Ball, BronzeTone Powder Coat Finish

= Specify Flagpole Height (20, 25, 30 etc.)
 *** = Specify Finish Option
 (Specified Finishes Applied to Truck Only.)



Outrigger Stationary Beacon Rope Halyard - Stationary - Cap Style Truck

FLAGPOLE TOP DIA.	BALL COLOR	DESCRIPTION	TOTAL LUMENS	BEACON SIZE	PART NUMBER	1+ SATIN	1+ POWDERCOAT
Beacon							
2"	Gold	Outrigger Stationary Beacon	500	8" Dia.	ABOS-202S-GLD-***	\$2,063	\$2,178
2.5"	Gold	Outrigger Stationary Beacon	500	8" Dia.	ABOS-20DS-GLD-***	\$2,063	\$2,178

Example Part #: ABOS-20DS-GLD-SAT
 American Beacon Outrigger Stationary Truck, 20' Flagpole, 2.5" Top Flagpole Diameter, Standard Beacon, Gold Anodized Ball, Satin Finish

Standard wire length on the Outrigger Stationary Beacon is 30'.

*** = Specify Finish Option
 (Specified Finishes Applied to Truck Only.)



American Beacon – Residential Series

The American Beacon Residential Series offers lighting options for External Halyard flagpoles in both Revolving and Stationary designs. These options provide the most environmentally correct way for flagpole illumination, properly lighting the flag during nighttime hours without lighting adjoining properties and the night sky!

- Revolving Option - External Halyard 359° Revolving Cap Style Truck
- 110 Volt System With Driver Contained Inside the Ball
- Can Be Converted to 12V for Solar Power Options
- Warm White, 3000K LED Light Rated for 25,000+ Hours
- 110V / 120V Input, 12 Volt Output
- Revolving Option - Wire Provided For Flagpole Height Plus 10' (*Stationary Option Wire Length is 30'*)

Patent #7,275,495

*** - Specify Finish Option
 SAT = Satin
 BZT = BronzeTone Powder Coat
 BLK = Black Powder Coat
 WHT = White Powder Coat

Residential Revolving Beacon

Rope Halyard - Revolving - Cap Style Truck

FLAGPOLE TOP DIA.	BALL COLOR	DESCRIPTION	TOTAL LUMENS	BEACON DIA.	PART NUMBER	1+ SATIN	1+ POWDERCOAT
1.875"-2"	Gold	Residential Revolving Beacon	250	5" Dia.	ABRR-##2S-GLD-***	\$969	\$1,084
1.875"-2"	Silver	Residential Revolving Beacon	250	5" Dia.	ABRR-##2S-SIL-***	\$969	\$1,084

= Specify Flagpole Height (20, 25, etc.)
 *** = Specify Finish Option
 (Specified Finishes Applied to Truck Only.)



Residential Stationary Beacon

Rope Halyard - Stationary - Cap Style Truck

FLAGPOLE TOP DIA.	DESCRIPTION	TOTAL LUMENS	BEACON DIA.	PART NUMBER	1+ SATIN	1+ POWDERCOAT
Gold						
1.875"-2"	Residential Stationary Beacon	250	5" Dia.	ABRS-##2S-GLD-***	\$588	\$703
2.5"	Residential Stationary Beacon	250	5" Dia.	ABRS-##DS-GLD-***	\$690	\$805
3"	Residential Stationary Beacon	250	5" Dia.	ABRS-##3S-GLD-***	\$713	\$828
Silver						
1.875"-2"	Residential Stationary Beacon	250	5" Dia.	ABRS-##2S-SIL-***	\$588	\$703
2.5"	Residential Stationary Beacon	250	5" Dia.	ABRS-##DS-SIL-***	\$690	\$805
3"	Residential Stationary Beacon	250	5" Dia.	ABRS-##3S-SIL-***	\$713	\$828

= Specify Flagpole Height (20, 25, etc.)
 *** = Specify Finish Option
 (Specified Finishes Applied to Truck Only.)



Solar Power Package

WATTAGE	PANEL DIMENSIONS	MAX POWER VOLTAGE	MAX POWER CURRENT	OPEN CURRENT VOLTAGE	PART NUMBER	1+
20W	470mm x 430mm x 17mm	17.3V	1.16A	21.4V	ABSP-2000	\$3,191
30W	360mm x 678mm x 25mm	18.25V	1.64A	21.96V	ABSP-3000	\$3,383
40W	678mm x 500mm x 25mm	18.25V	2.19A	21.96V	ABSP-4000	\$3,520

The American Beacon Solar Power Package includes one Solar Power Collector (20W, 30W, or 40W), one Battery Pack (9Ah, 12Ah, or 15Ah), and one Solar Power Pole Mount. Designed for use with our 12V Solar American Beacon designs (*sold separately*), this package allows for the proper illumination of the flag without the additional power expense.

Solar Power Pole Mount

- Used to attach a solar panel to the side of a flagpole
- Ultra-light and strong 5052 Aluminum

Solar Power Collector

- Panel Material – Monocrystalline High Efficiency Photovoltaic
- High Conversion Efficiency
- Low Power Tolerance of 0~+3%
- Low Degradation Under Light Exposure
- Withstands High Wind-Pressure, Snow Loads and Extreme Temperatures
- ISO 9001:2008 (*Quality Management System*) Certified Factory
- IEC61215, IEC61730, MCS CEC Certified Products
- TUV, CE Conformity

Solar Power Battery

- 3.2V 3000mAh Lithium Iron Phosphate Batteries
- Automatic Cell Balancing
- External on/off switch (*Off: For shipping and storage. On: Fully automatic mode*)
- Dusk to Dawn Auto-Switching Function
- All units field tested
- Internally fused: 1 Amp



Dealer Resources & Advantages



Flagpole Designer 2.0

Create millions of individual Flagpole Specification Drawings to match the requirements of any project.

Build custom poles for customers as well as provide cut sheets of the product selected. Perfect for submittals on commercial construction.



ATC Hazard Website

Check the recommended wind loads in a certain area to help customers find the right flagpole. We recommend using the ASCE 7-05 Wind Speed at the bottom as it is the measurement used by NAAMM.



Contact us for pricing and questions about dealer support!

Free Stamped Engineer Drawings

We offer Free Stamped Engineer Drawings for the following states: AL, GA, FL, IN, MA, NJ, PA, TN, and VA. All other states are subject to fees.

Foundation Calculations

Now offering ground sleeve foundation calculations with PE Stamp!

Freight Rater

Concord American Flagpole's Online Freight Quotes give you instant access to the industry's Lowest Freight Costs. Visit our video tutorial at <https://www.concordamericanflagpole.com/resources/online-freight-quotes/> to learn just how easy... and fast... flagpole freight quotes can be.



Flagpole Windspeed Calculations For Ground Set Installations Based on ANSI/NAAMM FP 1001-07

MTG.	BUTT HGT.	WALL THICKNESS	TOP DIAMETER	OVERALL LENGTH	FLAG SIZE*	EXTERNAL FLAGPOLES Estate ESS · Continental ESR · Xtreme XESR				INTERNAL - WINCH - REINFORCED Sovereignty ISW · Independence IRW · Xtreme XIRW				INTERNAL - WINCH - HINGED DOOR Titan IWW · Xtreme XIWW			
						No FLAG	SINGLE NYLON FLAG	SINGLE POLYESTER FLAG	DOUBLE NYLON FLAGS**	No FLAG	SINGLE NYLON FLAG	SINGLE POLYESTER FLAG	DOUBLE NYLON FLAGS**	No FLAG	SINGLE NYLON FLAG	SINGLE POLYESTER FLAG	DOUBLE NYLON FLAGS**
15'	3"	.125"	2"	17'	3' x 5'	149	113	103	102	-	-	-	-	-	-	-	-
	3"	.125"	2"	17'	2' x 3'	149	122	113	108	-	-	-	-	-	-	-	-
20'	3"	.125"	2"	22'	4' x 6'	108	83	76	74	-	-	-	-	-	-	-	-
	3"	.125"	2"	22'	3' x 5'	108	86	80	79	-	-	-	-	-	-	-	-
	4"	.125"	2"	22'	4' x 6'	147	109	97	98	-	-	-	-	-	-	-	-
	4"	.125"	2"	22'	3' x 5'	147	113	101	104	-	-	-	-	-	-	-	-
	5"	.125"	3"	22'	4' x 6'	229	136	123	119	-	-	-	-	-	-	-	-
	5"	.125"	3"	22'	3' x 5'	229	144	131	128	-	-	-	-	-	-	-	-
	5"	.156"	3"	22'	4' x 6'	262	160	142	136	262	160	142	136	-	-	-	-
	5"	.156"	3"	22'	3' x 5'	262	171	152	148	262	171	152	148	-	-	-	-
	5"	.188"	3"	22'	4' x 6'	287	182	160	153	287	182	160	153	-	-	-	-
	5"	.188"	3"	22'	3' x 5'	287	195	173	168	287	195	173	168	-	-	-	-
	6"	.156"	3.5"	22'	4' x 6'	301	208	187	178	301	208	187	178	256	152	135	129
	6"	.156"	3.5"	22'	3' x 5'	301	220	198	195	301	220	198	195	256	163	145	141
6"	.188"	3.5"	22'	4' x 6'	328	229	205	198	328	229	205	198	280	174	153	147	
6"	.188"	3.5"	22'	3' x 5'	328	242	218	215	328	242	218	215	280	186	165	161	
25'	3"	.125"	2"	26.5'	5' x 8'	83	63	58	56	-	-	-	-	-	-	-	-
	3"	.125"	2"	26.5'	4' x 6'	83	66	61	59	-	-	-	-	-	-	-	-
	4"	.125"	2"	26.5'	5' x 8'	106	83	75	75	-	-	-	-	-	-	-	-
	4"	.125"	2"	26.5'	4' x 6'	106	87	78	78	-	-	-	-	-	-	-	-
	5"	.125"	3"	26.5'	5' x 8'	136	98	90	89	-	-	-	-	-	-	-	-
	5"	.125"	3"	26.5'	4' x 6'	136	102	94	92	-	-	-	-	-	-	-	-
	5"	.156"	3"	26.5'	5' x 8'	178	111	99	99	178	111	99	99	-	-	-	-
	5"	.156"	3"	26.5'	4' x 6'	178	117	106	104	178	117	106	104	-	-	-	-
	5"	.188"	3"	26.5'	5' x 8'	209	124	112	109	209	124	112	109	-	-	-	-
	5"	.188"	3"	26.5'	4' x 6'	209	132	119	116	209	132	119	116	-	-	-	-
	5.5"	.188"	3.5"	26.5'	5' x 8'	231	146	130	124	-	-	-	-	-	-	-	-
	5.5"	.188"	3.5"	26.5'	4' x 6'	231	158	142	133	-	-	-	-	-	-	-	-
	6"	.156"	3.5"	26.5'	5' x 8'	230	149	132	126	230	149	132	126	162	100	92	90
	6"	.156"	3.5"	26.5'	4' x 6'	230	160	143	135	230	160	143	135	162	105	97	94
	6"	.188"	3.5"	26.5'	5' x 8'	253	168	150	143	253	168	150	143	192	112	102	99
	6"	.188"	3.5"	26.5'	4' x 6'	253	180	162	154	253	180	162	154	192	119	109	105
	6"	.250"	3.5"	26.5'	5' x 8'	287	197	177	169	287	197	177	169	231	137	122	118
	6"	.250"	3.5"	26.5'	4' x 6'	287	210	190	181	287	210	190	181	231	148	132	126
7"	.250"	3.5"	26.5'	5' x 8'	-	-	-	-	-	-	-	-	294	190	170	163	
7"	.250"	3.5"	26.5'	4' x 6'	-	-	-	-	-	-	-	-	294	204	184	175	
30'	4"	.125"	2"	33'	6' x 10'	85	66	59	58	-	-	-	-	-	-	-	-
	4"	.125"	2"	33'	5' x 8'	85	68	61	60	-	-	-	-	-	-	-	-
	5"	.125"	3"	33'	6' x 10'	96	78	71	71	-	-	-	-	-	-	-	-
	5"	.125"	3"	33'	5' x 8'	96	80	75	74	-	-	-	-	-	-	-	-
	5"	.156"	3"	33'	6' x 10'	112	86	80	78	112	86	80	78	-	-	-	-
	5"	.156"	3"	33'	5' x 8'	112	89	83	81	112	89	83	81	-	-	-	-
	5"	.188"	3"	33'	6' x 10'	131	94	86	85	131	94	86	85	-	-	-	-
	5"	.188"	3"	33'	5' x 8'	131	97	90	89	131	97	90	89	-	-	-	-
	6"	.156"	3.5"	33'	6' x 10'	174	108	98	95	174	108	98	95	98	75	71	69
	6"	.156"	3.5"	33'	5' x 8'	174	113	102	100	174	113	102	100	98	77	73	71
	6"	.188"	3.5"	33'	6' x 10'	197	122	110	106	197	122	110	106	114	83	77	75
	6"	.188"	3.5"	33'	5' x 8'	197	129	116	112	197	129	116	112	114	86	80	78
	6"	.250"	3.5"	33'	6' x 10'	229	150	132	126	229	150	132	126	159	98	90	87
	6"	.250"	3.5"	33'	5' x 8'	229	159	142	135	229	159	142	135	159	102	94	91
7"	.188"	3.5"	33'	6' x 10'	235	157	140	134	235	157	140	134	188	113	103	99	
7"	.188"	3.5"	33'	5' x 8'	235	165	150	143	235	165	150	143	188	119	108	104	
8"	.250"	3.5"	33'	6' x 10'	-	-	-	-	-	-	-	-	269	178	160	152	
8"	.250"	3.5"	33'	5' x 8'	-	-	-	-	-	-	-	-	269	188	170	162	
35'	5"	.125"	3"	38.5'	6' x 10'	78	66	60	60	-	-	-	-	-	-	-	-
	5"	.125"	3"	38.5'	5' x 8'	78	67	63	62	-	-	-	-	-	-	-	-
	5"	.156"	3"	38.5'	6' x 10'	87	73	68	66	87	73	68	66	-	-	-	-
	5"	.156"	3"	38.5'	5' x 8'	87	75	70	69	87	75	70	69	-	-	-	-
	5"	.188"	3"	38.5'	6' x 10'	95	79	73	72	95	79	73	72	-	-	-	-
	5"	.188"	3"	38.5'	5' x 8'	95	81	75	75	95	81	75	75	-	-	-	-
	6"	.156"	3.5"	38.5'	6' x 10'	116	87	79	78	116	87	79	78	-	-	-	-
	6"	.156"	3.5"	38.5'	5' x 8'	116	90	81	81	116	90	81	81	-	-	-	-
	6"	.188"	3.5"	38.5'	6' x 10'	145	97	90	87	145	97	90	87	-	-	-	-
	6"	.188"	3.5"	38.5'	5' x 8'	145	101	92	91	145	101	92	91	-	-	-	-
	7"	.156"	3.5"	38.5'	6' x 10'	165	110	101	97	165	110	101	97	106	80	75	73
	7"	.156"	3.5"	38.5'	5' x 8'	165	116	106	102	165	116	106	102	106	83	78	76
	7"	.188"	3.5"	38.5'	6' x 10'	187	127	114	109	187	127	114	109	127	90	84	81
	7"	.188"	3.5"	38.5'	5' x 8'	187	134	121	115	187	134	121	115	127	93	87	84
7"	.250"	3.5"	38.5'	6' x 10'	219	153	138	131	-	-	-	-	-	-	-	-	
7"	.250"	3.5"	38.5'	5' x 8'	219	161	140	140	-	-	-	-	-	-	-	-	



Call Concord American Flagpole for Wind Speed information on Shoe Base, Wall Mount, Rooftop and Nautical Flagpole Installations and for Flag Size applications NOT listed.

*NAAMM recommended maximum flag sizes are shaded.
 **Double Flags calculated on NAAMM recommended maximum size and one size down (i.e. 5' x 8' and 4' x 6' for 25' flagpoles). Exception: 2' x 3' use the same size for both flags.
 NOT ALL LISTED SIZES ARE STANDARD

Flagpole Windspeed Calculations For Ground Set Installations Based on ANSI/NAAMM FP 1001-07

MTG. HGT.	BUTT DIAMETER	WALL THICKNESS	TOP DIAMETER	OVERALL LENGTH	OVERALL FLAG SIZE*	EXTERNAL FLAGPOLES Estate ESS - Continental ESR - Xtreme XESR				INTERNAL - WINCH - REINFORCED Sovereignty ISW - Independence IRW - Xtreme XIRW				INTERNAL - WINCH - HINGED DOOR Titan IWW - Xtreme XIWW			
						No FLAG	SINGLE NYLON FLAG	SINGLE POLYESTER FLAG	DOUBLE NYLON FLAGS**	No FLAG	SINGLE NYLON FLAG	SINGLE POLYESTER FLAG	DOUBLE NYLON FLAGS**	No FLAG	SINGLE NYLON FLAG	SINGLE POLYESTER FLAG	DOUBLE NYLON FLAGS**
						35'	8"	.188"	4"	38.5'	6' x 10'	-	-	-	-	213	155
	8"	.188"	4"	38.5'	5' x 8'	-	-	-	-	213	162	148	142	179	125	113	108
	8"	.250"	4"	38.5'	6' x 10'	249	181	164	157	249	181	164	157	212	144	130	123
	8"	.250"	4"	38.5'	5' x 8'	249	189	172	166	249	189	172	166	212	151	137	131
	8"	.312"	3.5"	38.5'	6' x 10'	-	-	-	-	-	-	-	-	237	164	148	141
	8"	.312"	3.5"	38.5'	5' x 8'	-	-	-	-	-	-	-	-	237	173	157	150
40'	7"	.156"	3.5"	44'	8' x 12'	122	87	79	78	122	87	79	78	80	65	61	60
	7"	.156"	3.5"	44'	6' x 10'	122	90	82	81	122	90	82	81	80	66	63	61
	8"	.156"	4"	44'	8' x 12'	157	107	96	93	157	107	96	93	112	80	74	72
	8"	.156"	4"	44'	6' x 10'	157	113	102	98	157	113	102	98	112	83	78	75
	8"	.188"	4"	44'	8' x 12'	177	123	110	106	177	123	110	106	136	90	83	80
	8"	.188"	4"	44'	6' x 10'	177	129	118	112	177	129	118	112	136	94	87	84
	8"	.250"	4"	44'	8' x 12'	205	146	132	127	205	146	132	127	167	110	100	96
	8"	.250"	4"	44'	6' x 10'	205	154	141	134	205	154	141	134	167	117	106	101
	8"	.312"	3.5"	44'	8' x 12'	231	165	150	144	-	-	-	-	-	-	-	-
	8"	.312"	3.5"	44'	6' x 10'	231	174	159	151	-	-	-	-	-	-	-	-
	10"	.188"	4"	44'	8' x 12'	-	-	-	-	226	166	148	145	204	141	127	122
	10"	.188"	4"	44'	6' x 10'	-	-	-	-	226	174	156	152	204	149	135	129
	10"	.250"	4"	44'	8' x 12'	-	-	-	-	259	192	171	169	234	166	151	145
	10"	.250"	4"	44'	6' x 10'	-	-	-	-	259	201	179	177	234	175	160	152
45'	8"	.188"	4"	49.5'	8' x 12'	144	102	92	89	144	102	92	89	100	76	70	68
	8"	.188"	4"	49.5'	6' x 10'	144	107	97	94	144	107	97	94	100	79	73	71
	8"	.250"	4"	49.5'	8' x 12'	-	-	-	-	173	125	115	108	-	-	-	-
	8"	.250"	4"	49.5'	6' x 10'	-	-	-	-	173	131	122	114	-	-	-	-
	10"	.188"	4"	49.5'	8' x 12'	-	-	-	-	192	143	130	125	167	118	107	102
	10"	.188"	4"	49.5'	6' x 10'	-	-	-	-	192	150	137	132	167	124	114	108
	10"	.219"	4"	49.5'	8' x 12'	-	-	-	-	208	156	141	137	-	-	-	-
	10"	.219"	4"	49.5'	6' x 10'	-	-	-	-	208	163	148	144	-	-	-	-
	10"	.250"	4"	49.5'	8' x 12'	-	-	153	-	-	-	153	-	-	-	-	-
	10"	.250"	4"	49.5'	6' x 10'	226	168	159	155	226	168	159	155	-	-	-	-
50'	8"	.188"	3.5"	55'	10' x 15'	117	83	75	74	117	83	75	74	-	-	-	-
	8"	.188"	3.5"	55'	8' x 12'	117	86	79	77	117	86	79	77	-	-	-	-
	10"	.188"	4"	55'	10' x 15'	164	118	107	103	164	118	107	103	136	94	87	84
	10"	.188"	4"	55'	8' x 12'	164	123	113	109	164	123	113	109	136	99	91	88
	10"	.250"	4"	55'	10' x 15'	191	140	126	123	191	140	126	123	165	115	104	100
	10"	.250"	4"	55'	8' x 12'	191	147	132	130	191	147	132	130	165	121	110	106
	10"	.312"	4"	55'	10' x 15'	213	158	143	139	213	158	143	139	186	132	120	115
	10"	.312"	4"	55'	8' x 12'	213	165	150	147	213	165	150	147	186	139	127	121
	12"	.250"	4"	55'	10' x 15'	242	179	156	157	242	179	156	157	222	158	143	138
	12"	.250"	4"	55'	8' x 12'	242	187	163	166	242	187	163	166	222	166	152	145
	12"	.250"	4"	55'	10' x 15'	-	-	-	-	-	-	-	-	246	178	162	156
	12"	.250"	4"	55'	8' x 12'	-	-	-	-	-	-	-	-	246	187	172	164
55'	10"	.188"	4"	60.5'	10' x 15'	139	102	94	90	139	102	94	90	-	-	-	-
	10"	.188"	4"	60.5'	8' x 12'	139	107	99	95	139	107	99	95	-	-	-	-
60'	10"	.188"	4"	66'	12' x 18'	118	86	78	76	118	86	78	76	89	68	63	61
	10"	.188"	4"	66'	10' x 15'	118	89	81	79	118	89	81	79	89	70	66	64
	10"	.250"	4"	66'	12' x 18'	143	104	95	91	143	104	95	91	113	82	76	73
	10"	.250"	4"	66'	10' x 15'	143	108	99	96	143	108	99	96	113	85	79	76
	10"	.312"	4"	66'	12' x 18'	-	-	-	-	162	119	110	104	-	-	-	-
	10"	.312"	4"	66'	10' x 15'	-	-	-	-	162	124	115	109	-	-	-	-
	12"	.250"	4"	66'	12' x 18'	187	137	122	120	187	137	123	120	166	117	106	101
	12"	.250"	4"	66'	10' x 15'	187	142	128	126	187	142	128	126	166	121	111	107
	12"	.312"	4"	66'	12' x 18'	209	155	138	136	209	155	138	136	-	-	-	-
	12"	.312"	4"	66'	10' x 15'	209	161	143	142	209	161	143	142	-	-	-	-
	12"	.375"	4"	66'	12' x 18'	228	171	151	150	228	171	151	150	205	149	136	130
	12"	.375"	4"	66'	10' x 15'	228	177	157	157	228	177	157	157	205	155	142	137
65'	10"	.312"	4"	71.5'	12' x 18'	142	106	97	93	142	106	97	93	-	-	-	-
	10"	.312"	4"	71.5'	10' x 15'	142	109	100	97	142	109	100	97	-	-	-	-
	12"	.250"	4"	71.5'	12' x 18'	165	122	111	105	165	122	111	105	-	-	-	-
	12"	.250"	4"	71.5'	10' x 15'	165	127	115	109	165	127	115	109	-	-	-	-
70'	10"	.312"	4"	77'	12' x 18'	123	94	85	82	123	94	85	82	94	72	67	65
	10"	.312"	4"	77'	10' x 15'	123	97	89	86	123	97	89	86	94	74	70	68
	12"	.250"	4"	77'	12' x 18'	145	109	100	96	145	109	100	96	122	90	84	81
	12"	.250"	4"	77'	10' x 15'	145	113	103	101	145	113	103	101	122	94	87	85
	12"	.375"	4"	77'	12' x 18'	181	139	126	123	181	139	126	123	-	-	-	-
	12"	.375"	4"	77'	10' x 15'	181	144	130	128	181	144	130	128	-	-	-	-
75'	12"	.375"	4"	82.5'	12' x 18'	161	126	115	111	161	126	115	111	-	-	-	-
	12"	.375"	4"	82.5'	10' x 15'	161	130	119	116	161	130	119	116	-	-	-	-
80'	12"	.375"	4"	88'	15' x 25'	144	107	99	95	144	107	99	95	121	89	82	80
	12"	.375"	4"	88'	12' x 18'	144	113	105	103	144	113	105	103	121	94	87	84

Call Concord American Flagpole for Wind Speed information on Shoe Base, Wall Mount, Rooftop and Nautical Flagpole Installations and for Flag Size applications NOT listed.

*NAAMM recommended maximum flag sizes are shaded.
 **Double Flags calculated on NAAMM recommended maximum size and one size down (i.e. 5' x 8' and 4' x 6' for 25' flagpoles). Exception: 2' x 3' use the same size for both flags.
 NOT ALL LISTED SIZES ARE STANDARD



Flagpole Windspeed Calculations For Ground Set Installations

Based on ANSI/NAAMM FP 1001-07

MTG.	BUTT HGT.	WALL THICKNESS	TOP DIAMETER	OVERALL LENGTH	FLAG SIZE*	INTERNAL - CAM CLEAT - REINFORCED Sentry ISC - Sentry II IRC				INTERNAL - CAM CLEAT - HINGED DOOR Monarch ICC			
						No FLAG	SINGLE NYLON FLAG	SINGLE POLYESTER FLAG	DOUBLE NYLON FLAGS**	No FLAG	SINGLE NYLON FLAG	SINGLE POLYESTER FLAG	DOUBLE NYLON FLAGS**
20'	5"	.125"	3"	22'	4' x 6'	229	136	123	119	204	117	108	105
	5"	.125"	3"	22'	3' x 5'	229	144	131	128	204	123	113	111
	5"	.156"	3"	22'	4' x 6'	262	160	142	136	244	134	121	118
	5"	.156"	3"	22'	3' x 5'	262	171	152	148	244	142	129	126
	5"	.188"	3"	22'	4' x 6'	287	182	160	153	272	151	135	130
	5"	.188"	3"	22'	3' x 5'	287	195	173	168	272	162	144	141
	6"	.156"	3.5"	22'	4' x 6'	301	208	187	178	301	194	171	164
	6"	.156"	3.5"	22'	3' x 5'	301	220	198	195	301	206	185	180
25'	5"	.125"	3"	26.5'	4' x 6'	328	229	205	198	328	215	192	183
	5"	.125"	3"	26.5'	3' x 5'	328	242	218	215	328	228	205	200
	5"	.125"	3"	26.5'	5' x 8'	136	98	90	89	110	84	78	76
	5"	.125"	3"	26.5'	4' x 6'	136	102	94	92	110	87	82	79
	5"	.156"	3"	26.5'	5' x 8'	178	111	99	99	129	93	87	84
	5"	.156"	3"	26.5'	4' x 6'	178	117	106	104	129	97	91	88
	5"	.188"	3"	26.5'	5' x 8'	209	124	112	109	157	102	94	92
	5"	.188"	3"	26.5'	4' x 6'	209	132	119	116	157	107	100	96
	5.5"	.188"	3.5"	26.5'	5' x 8'	231	146	130	124	209	120	109	105
	5.5"	.188"	3.5"	26.5'	4' x 6'	231	158	142	133	209	128	116	111
	6"	.156"	3.5"	26.5'	5' x 8'	230	149	132	126	216	126	114	110
	6"	.156"	3.5"	26.5'	4' x 6'	230	160	143	135	216	136	122	117
	6"	.188"	3.5"	26.5'	5' x 8'	253	168	150	143	240	144	128	123
	6"	.188"	3.5"	26.5'	4' x 6'	253	180	162	154	240	156	139	132
	6"	.250"	3.5"	26.5'	5' x 8'	287	197	177	169	274	174	154	148
	6"	.250"	3.5"	26.5'	4' x 6'	287	210	190	181	274	187	167	159
30'	5"	.125"	3"	33'	6' x 10'	96	78	71	71	-	-	-	-
	5"	.125"	3"	33'	5' x 8'	96	80	75	74	-	-	-	-
	5"	.156"	3"	33'	6' x 10'	112	86	80	78	90	72	67	65
	5"	.156"	3"	33'	5' x 8'	112	89	83	81	90	74	70	68
	5"	.188"	3"	33'	6' x 10'	131	94	86	85	-	-	-	-
	5"	.188"	3"	33'	5' x 8'	131	97	90	89	-	-	-	-
	6"	.156"	3.5"	33'	6' x 10'	174	108	98	95	138	91	85	82
	6"	.156"	3.5"	33'	5' x 8'	174	113	102	100	138	95	88	86
	6"	.188"	3.5"	33'	6' x 10'	197	122	110	106	170	102	94	91
	6"	.188"	3.5"	33'	5' x 8'	197	129	116	112	170	107	98	95
	6"	.250"	3.5"	33'	6' x 10'	229	150	132	126	-	-	-	-
	6"	.250"	3.5"	33'	5' x 8'	229	159	142	135	-	-	-	-
	7"	.188"	3.5"	33'	6' x 10'	235	157	140	134	-	-	-	-
	7"	.188"	3.5"	33'	5' x 8'	235	165	150	143	-	-	-	-
35'	5"	.125"	3"	38.5'	6' x 10'	78	66	60	60	-	-	-	-
	5"	.125"	3"	38.5'	5' x 8'	78	67	63	62	-	-	-	-
	5"	.156"	3"	38.5'	6' x 10'	87	73	68	66	-	-	-	-
	5"	.156"	3"	38.5'	5' x 8'	87	75	70	69	-	-	-	-
	5"	.188"	3"	38.5'	6' x 10'	95	79	73	72	-	-	-	-
	5"	.188"	3"	38.5'	5' x 8'	95	81	75	75	-	-	-	-
	6"	.156"	3.5"	38.5'	6' x 10'	116	87	79	78	93	74	70	68
	6"	.156"	3.5"	38.5'	5' x 8'	116	90	81	81	93	76	72	70
	6"	.188"	3.5"	38.5'	6' x 10'	145	97	90	87	107	81	76	74
	6"	.188"	3.5"	38.5'	5' x 8'	145	101	92	91	107	84	79	77
	7"	.156"	3.5"	38.5'	6' x 10'	165	110	101	97	142	95	88	85
	7"	.156"	3.5"	38.5'	5' x 8'	165	116	106	102	142	99	92	89
	7"	.188"	3.5"	38.5'	6' x 10'	187	127	114	109	167	107	99	95
	7"	.188"	3.5"	38.5'	5' x 8'	187	134	121	115	167	112	103	99
	8"	.188"	4"	38.5'	6' x 10'	213	155	140	134	-	-	-	-
	8"	.188"	4"	38.5'	5' x 8'	213	162	148	142	-	-	-	-
8"	.250"	4"	38.5'	6' x 10'	244	181	164	157	-	-	-	-	
8"	.250"	4"	38.5'	5' x 8'	244	189	172	167	-	-	-	-	
40'	7"	.156"	3.5"	44'	8' x 12'	122	87	79	78	99	75	70	68
	7"	.156"	3.5"	44'	6' x 10'	122	90	82	81	99	78	73	71
	8"	.156"	4"	44'	8' x 12'	157	107	96	93	141	93	85	83
	8"	.156"	4"	44'	6' x 10'	157	113	102	98	141	97	90	86
	8"	.188"	4"	44'	8' x 12'	177	123	110	106	162	106	96	93
	8"	.188"	4"	44'	6' x 10'	177	129	118	112	162	112	102	97
	8"	.250"	4"	44'	8' x 12'	205	146	132	127	-	-	-	-
	8"	.250"	4"	44'	6' x 10'	205	154	141	134	-	-	-	-

Call Concord American Flagpole for Wind Speed information on Shoe Base, Wall Mount, Rooftop and Nautical Flagpole Installations and for Flag Size applications NOT listed.

*NAAMM recommended maximum flag sizes are shaded.

**Double Flags calculated on NAAMM recommended maximum size and one size down (i.e. 5' x 8' and 4' x 6' for 25' flagpoles). Exception: 2' x 3' use the same size for both flags.

NOT ALL LISTED SIZES ARE STANDARD



Terms and Conditions of Sale

Conditions

All orders or contracts are accepted with the understanding that they are subject to Concord American Flagpole's (CAFP) ability to obtain the necessary raw materials, and all orders or contracts as well as shipments applicable thereto are subject to CAFP's current manufacturing schedules, and government regulations, orders, directives and restrictions that may be in effect from time to time.

Quotations

Written quotations automatically expire thirty (30) calendar days from the date issued unless otherwise stated on the face of the quotation. Quotations are subject to termination by notice within that period. Quotations are subject to correction in the event of stenographic or clerical errors. Prices quoted are for specific quantities shown, released for manufacture and shipment at one time to one destination unless otherwise stated. Any change in the quantity of an order and/or split shipments are subject to price revision.

Prices

Prices shown in this price list are Recommended List Prices and do not include freight or installation costs. Dealer discounts are applicable. Prices are FOB shipping facility. CAFP will pay the freight and add a freight charge to the invoice. Upon request, motor freight shipments can be shipped collect or as a prepaid in the name of the invoice bill-to. Purchases are invoiced at the time of shipment. Applications for an open account should be submitted in advance of placing the first order. Credit card orders are accepted.

To qualify for listed Quantity discounts, the following guidelines are in effect:

- Quantities of similar items within a product group of similar groups may be mixed to achieve the discounted pricing.
- The order should be a single order shipping to a single destination. Contact Customer Service for blanket or multiple release orders.

Prices are subject to change without notice and orders calling for future shipment will be billed according to the price in effect at the time of shipment, unless otherwise specified.

Taxes

Prices on the specified products are exclusive of all city, state and federal excise taxes, including without limitation, taxes on manufacture, sales, receipts, gross income, occupation, use and similar taxes. Wherever applicable, any tax or taxes will be added to the invoice as a separate charge to be paid by the Buyer.

Shipment

All prices are F.O.B. factory of origination (TX, VA, or MN), unless otherwise stated. Method and route of shipment are at CAFP's discretion, unless the Buyer supplies explicit shipping instructions. When Buyer specifies method of shipment, any additional shipping expense will be charged to Buyer. Shipping charges are not intended to guarantee the delivery at or to destination. Identification of goods to the contract shall occur as each shipment is placed in the hands of the carrier.

Deliveries

Deliveries shall be subject to, and contingent upon, strikes, labor difficulties, civil unrest, war, fire, delay or defaults of common carriers, failure or curtailment in CAFP's usual sources of supply, governmental decrees or orders, or without limiting the foregoing, any other delays beyond CAFP's reasonable control, and CAFP shall not be liable for any loss or damage arising therefrom. CAFP shall have the additional right, in the event of the happening of any of the above contingencies, at its option, to cancel this contract or any part thereof, without any resulting liability. Shipments made within twenty (20) days after specified date of delivery shall constitute a good delivery. Any delivery not in dispute shall be paid for regardless of other controversies relating to other delivered or undelivered merchandise.

If merchandise is delivered showing signs of freight damage, refuse the shipment and contact Customer Service within three (3) business days. We will promptly reship your order and file a freight claim for the damages. If a visually damaged shipment is accepted and the damage later claimed, the responsibility for filing the claim may be that of the customer.

Packaging

Unless otherwise stated on the face of the quotation, all packaging will be in accordance with CAFP's standard practices for domestic shipments. Cartons of parts are carefully packed. CAFP will not be responsible for any shortages if they are not reported within 30 days of receipt.

NOTE: Satin aluminum flagpole shafts can stain if allowed to remain in contact with wet or damp wrappings. If there is any sign of moisture, immediately remove the shaft from the tube, unwrap, and dry immediately. If the shaft is to be stored outdoors, it must be stored off the ground and unwrapped.

Limited Lifetime Warranty For Flagpoles

Concord American Flagpole ("CAFP") warrants to the first purchaser ("Buyer") of a CAFP flagpole shaft (the "Flagpole") that the Flagpole will, upon shipment by CAFP, be free from defects in material and workmanship and to be free from corrosion except those items normally consumed in service (the "Warranty"). The Warranty applies to the pole shaft only and excludes anchor bolts, flagpole accessories, foundations and finishes such as powder coating and anodizing. CAFP provides separate warranties for its anodized and powder coated finishes and for hardware and other Flagpole accessories. WITH RESPECT TO FLAGS, CAFP MAKES NO, AND EXPRESSLY DISCLAIMS, ALL WARRANTIES.

If any failure to conform to the Warranty appears, and written notice of such failure is given to CAFP during the lifetime of the Flagpole's intended use (the "Warranty Period"), CAFP will, upon substantiation of such nonconformity and at its sole option, either repair or replace the non-conforming Flagpole. Specifically excluded from the Warranty is the cost to remove, ship, replace, or reinstall the non-conforming or repaired/replaced Flagpole. Repair or replacement by CAFP is the Buyer's sole remedy, and CAFP's sole obligation, in the event of a failure to conform to the Warranty. The Warranty does not cover defects or failures resulting from improper maintenance, misuse, abuse, radiation, overloading, accident, acts of God, or other casualty beyond the control of CAFP, alterations, modification or additions without written permission from CAFP, or from failures or corrosion due to:

(continued on page 94)



(continued from page 93)

- Improper installation.
- Misapplication – product used outside of specified use.
- Damage from handling, transportation, installation, vehicular impact, abuse, or vandalism.
- Site specific wind induced or other vibration.
- Installation in soils with a pH under 5 or over 9.
- Installation using highly caustic grouts or concrete.
- Improper grounding.

All warranty claims must be directed to: CONCORD AMERICAN FLAGPOLE, Customer Service Department, 4155 Patriot Drive, Grapevine, Texas 76051. The Flagpole shall not be returned without prior written authorization of CAFP and must be shipped freight prepaid by the Buyer. If CAFP elects to replace the nonconforming Flagpole, such replaced Flagpole shall become the property of CAFP.

CAFP MAKES NO OTHER EXPRESS WARRANTY AND EXPRESSLY DISCLAIMS ANY WARRANTY OF MERCHANTABILITY OR FITNESS FOR A PARTICULAR PURPOSE AND ALL OTHER IMPLIED WARRANTIES OTHER THAN THOSE THAT MAY NOT BE DISCLAIMED AS A MATTER OF LAW. THE DURATION OF ANY IMPLIED WARRANTY THAT MAY NOT BE DISCLAIMED BY APPLICABLE STATE OR FEDERAL LAW IS LIMITED TO THE WARRANTY PERIOD.

Regardless of whether a claim against CAFP is based on the Warranty or is an action in contract, tort (*negligence or strict liability*) or otherwise, CAFP's liability for losses, damages, or expenses of any kind arising from the design, manufacture, installation, use, repair, or sale of the flagpole is limited, unless otherwise prohibited by applicable law, to an amount not exceeding the cost of the CAFP flagpole giving rise to such liability. CAFP shall not be liable or responsible for any indirect, incidental, consequential or special damages.

Some states do not allow limitations on how long an implied warranty lasts or the exclusion or limitation of incidental or consequential damages, so the above limitations and exclusion may not apply to you. This warranty gives you specific legal rights and you may also have other rights which may vary from state to state.

Limited One-Year Warranty



For Flagpole Accessories

Concord American Flagpole ("CAFP") warrants to the first purchaser ("Buyer") of a CAFP aluminum flagpole that the accessories other than flags (*the "Accessories"*) accompanying the flagpole or sold as replacement component parts will, upon shipment by CAFP, be free from defects in material and workmanship (*the "Warranty"*).

If any failure to conform to the Warranty appears and written notice of such failure is given to CAFP within one (1) year from the date of shipment by CAFP (*the "Warranty Period"*), CAFP will, upon substantiation of such failure and at its sole option, either repair or replace the non-conforming Accessory. Specifically excluded from the Warranty is the cost to remove, ship, or reinstall the flagpole or the Accessory. Repair or replacement by CAFP is the Buyer's sole remedy, and CAFP's sole obligation, in the event of a failure to conform to the Warranty. The Warranty does not cover defects or failures resulting from improper installation or maintenance, misuse, abuse, radiation, overloading, accident, acts of God, alterations, modification or additions without written permission from CAFP, or any other occurrences beyond the control of CAFP.

Limited One-Year Warranty For Anodized Finish

Concord American Flagpole ("CAFP") warrants to the first purchaser ("Buyer") of a CAFP aluminum flagpole that the anodized finish (*the "Finish"*) on the flagpole will, upon shipment by CAFP, be free from defects in material and workmanship (*the "Warranty"*).

If the Finish exhibits any excessive fading due to normal climatic exposure, and written notice of such failure is given to CAFP within one (1) year from the date of shipment by CAFP (*the "Warranty Period"*), CAFP will, upon substantiation of such failure and at its sole option, either repair or replace the Finish. Anodizing is an electro-chemical process resulting in a colored aluminum oxide layer on the flagpole surface. Color variation will inherently occur between the tube (*Alloy 6063-T6*), castings (*Alloy 356*) and weld metal (*Alloy 4043*). Minute differences in the surface properties of the tube caused by fabrication processes such as tapering can also result in slight color variation of anodized finishes. These variations are more pronounced in light and medium color anodizing. These color variations in anodized finishes are not defects or failures and are not covered by the Warranty. Specifically excluded from the Warranty is the cost to remove, ship, or reinstall

the flagpole with the Finish. Repair or replacement by CAFP is the Buyer's sole remedy, and CAFP's sole obligation, in the event of a failure to conform to the Warranty. The Warranty does not cover defects or failures resulting from improper installation or maintenance, misuse, abuse, radiation, overloading, use of caustic cleaning agents, accident, acts of God or other casualty beyond the control of CAFP.

Limited One-Year Warranty For Powder Coated Finish

Concord American Flagpole ("CAFP") warrants to the first purchaser ("Buyer") of a CAFP aluminum flagpole that the factory-applied powder coating (*the "Coating"*) on the flagpole will, upon shipment by CAFP, be free from defects in material and workmanship (*the "Warranty"*).

If the Coating exhibits any cracking, peeling or excessive fading, and written notice of such failure is given to CAFP within one (1) year from the date of shipment by CAFP (*the "Warranty Period"*), CAFP will, upon substantiation of such failure and at its sole option, either repair or replace the Coating. Specifically excluded from the Warranty is the cost to remove, ship, or reinstall the flagpole with the Coating. Repair or replacement by CAFP is the Buyer's sole remedy, and CAFP's sole obligation, in the event of a failure to conform to the Warranty. The Warranty does not cover defects or failures resulting from improper installation or maintenance, misuse, abuse, radiation, overloading, use of caustic cleaning agents, accident, acts of God or other casualty beyond the control of CAFP.

Limitations of Warranties

Flagpole shafts and Accessory cartons should be inspected upon delivery. Products are carefully packaged and while visible damage does not guarantee automatic flagpole or accessory damage, it is a reason to inspect more closely. Note any sign of damage or shortage on the freight bill when signing for the product. Warranties do not cover failure to notify common carriers of apparent or concealed damages when receiving merchandise or staining on Satin finish flagpoles due to failure to remove product from wet or damp wrappings.

(continued on page 95)

Limitations of Remedy

CAFP MAKES NO OTHER EXPRESS

WARRANTY AND EXPRESSLY DISCLAIMS ANY WARRANTY OF MERCHANTABILITY OR FITNESS FOR A PARTICULAR PURPOSE AND ALL OTHER IMPLIED WARRANTIES OTHER THAN THOSE THAT MAY NOT BE DISCLAIMED AS A MATTER OF LAW. THE DURATION OF ANY IMPLIED WARRANTY THAT MAY NOT BE DISCLAIMED BY APPLICABLE STATE OR FEDERAL LAW IS LIMITED TO THE WARRANTY PERIOD.

Regardless of whether a claim against CAFP is based on the warranty or is an action in contract, tort (*negligence or strict liability*) or otherwise, CAFP's liability for losses, damages, or expenses of any kind arising from the design, manufacture, installation, use, repair, or sale of the flagpole is limited, unless otherwise prohibited by applicable law, to an amount not exceeding the cost of the CAFP flagpole giving rise to such liability. CAFP shall not be liable or responsible for any indirect, incidental, consequential or special damages.

Warranty Service

All warranty claims must be directed to: CONCORD AMERICAN FLAGPOLE, Customer Service Department, 4155 Patriot Drive, Suite 100, Grapevine, TX 76051. Neither the flagpole nor the Accessory shall be returned without prior written authorization of CAFP and must be shipped freight prepaid by the Buyer. For further information, you may call CAFP Customer Service at 800-527-3902.

Legal Rights

Some states do not allow limitations on how long an implied warranty lasts or the exclusion or limitation of incidental or consequential damages, so the above limitations and exclusion may not apply to you. This warranty gives you specific legal rights and you may also have other rights which may vary from state to state.

CAFP's Right of Possession

CAFP shall have the right, in addition to all others it may possess, at any time,

for credit reasons or because of Buyer's default or defaults, to withhold shipments, in whole or in part, and to recall goods in transit, retake same, and repossess all good which may be stored with CAFP for Buyer's account, without the necessity of taking any other proceedings, and Buyer consents that all the merchandise is so recalled, retaken or repossessed shall become CAFP's absolute property, provided that the Buyer is given full credit therefor. The foregoing shall not be construed as limiting, in any manner, any of the rights or remedies available to CAFP because of any default of Buyer under the Uniform Commercial Code as in force and effect in the Commonwealth of Virginia on the date of order of acceptance.

Controlling Provisions

These terms and conditions shall supersede any provisions, terms and conditions contained on any confirmation order, or other writing Buyer may give or receive, and the rights of the parties shall be governed exclusively by the provisions, terms and conditions hereof. CAFP makes no representations or warranties concerning any order except such as are expressly contained herein, and, these terms and conditions may not be changed or modified orally.

Purchase Order

If this quotation is accepted and Buyer's order form is used for the purpose, it is expressly understood and agreed that the terms and conditions herein set forth shall prevail insofar as the same may in any way conflict with the terms and conditions set forth in such order form, and the issuance of such order by Buyer shall be deemed to note Buyer's assent to the foregoing.

Payment Terms

Net amount of invoice is due and payable in full within thirty (30) days of invoice date. If in CAFP's opinion, the financial condition of the Buyer at any time does not justify continuance of production or shipment on the terms of payment specified, CAFP may require full or partial payment in advance of manufacture or shipment. Any indebtedness owing to CAFP for a period longer than thirty (30) days shall bear interest until paid at the current prime rate published in the Wall Street Journal. If CAFP finds it necessary to place any indebtedness hereunder in the hands of an attorney for collection, the Buyer shall pay all expenses and costs of collection, including reasonable attorney's fees.

Liability

CAFP shall not be liable for loss or damage of any kind resulting from delay or inability

to deliver on account of fire, labor troubles, accident, acts of civil or military authorities, or from any other cause beyond CAFP's control.

Cancellation

An order once placed and accepted by CAFP can be canceled only with CAFP's consent and upon terms that will indemnify CAFP against loss.

Returned Material

In no case are goods to be returned without prior written consent. Only unused material as currently manufactured, which has been invoiced to Buyer within ninety (90) days, will be considered for return. Material accepted for credit is subject to a minimum service charge of twenty-five percent (25%) plus all transportation charges. Material built to order is not subject to return for credit under any circumstances. Goods must be securely packaged to reach CAFP without damage.

General

The provisions on the face hereof and these Terms and Conditions constitute the entire agreement among the parties and supersede the provisions of any purchase order, other communication between the parties or any statement or representation not included herein. This agreement may not be modified or amended except in a writing signed by the party intended to be bound thereby. This agreement shall be governed by the laws of the Commonwealth of Virginia.

Concord American Flagpole warrants its aluminum flagpole shafts for their LIFETIME

By combining industry-leading manufacturing technologies with exceptional Engineering and Design, Concord American Flagpole provides the highest quality products available to the industry today. We truly believe in the longevity and durability of our aluminum flagpole assemblies, and are proud to offer the flagpole industry's first Lifetime Flagpole Shaft Warranty. *(Residential Flagpole Kits excluded.)*

Concord American Flagpole Limited Warranty — Hardware and Accessories

In addition to the Lifetime Flagpole Shaft Warranty, Concord American Flagpole warrants hardware and accessories to be free from defects in material and workmanship for a period of one year from the date of shipment *(Flags and other exceptions noted)*. This Best-in-Class Warranty is made possible through strict Vendor Certification guidelines and a dedication to superior Quality Control.

Visit www.ConcordAmericanFlagpole.com for complete Warranty information.

Restock Policy

Any purchase order where material and/or labor has been applied is subject to a (25%) restocking fee against the cost of the cancelled items. This fee will be invoiced as a separate statement referencing the original purchase order.

Storage of Materials

All material placed as part of an order scheduled to be a customer pickup will be stored onsite for a maximum of (20) calendar days. After the term of (20) calendar days has been surpassed the order will be cancelled and the restock policy will be applied.



Limited Lifetime Warranty For Flagpoles

Concord American Flagpole ("CAFP") warrants to the first purchaser ("Buyer") of a CAFP flagpole shaft (the "Flagpole") that the Flagpole will, upon shipment by CAFP, be free from defects in material and workmanship and to be free from corrosion except those items normally consumed in service (the "Warranty"). The Warranty applies to the pole shaft only and excludes anchor bolts, flagpole accessories, foundations and finishes such as powder coating and anodizing. CAFP provides separate warranties for its anodized and powder coated finishes and for hardware and other Flagpole accessories. **WITH RESPECT TO FLAGS, CAFP MAKES NO, AND EXPRESSLY DISCLAIMS, ALL WARRANTIES.**

If any failure to conform to the Warranty appears, and written notice of such failure is given to CAFP during the lifetime of the Flagpole's intended use (the "Warranty Period"), CAFP will, upon substantiation of such nonconformity and at its sole option, either repair or replace the non-conforming Flagpole. Specifically excluded from the Warranty is the cost to remove, ship, replace, or reinstall the non-conforming or repaired/replaced Flagpole. Repair or replacement by CAFP is the Buyer's sole remedy, and CAFP's sole obligation, in the event of a failure to conform to the Warranty. The Warranty does not cover defects or failures resulting from improper maintenance, misuse, abuse, radiation, overloading, accident, acts of God, or other casualty beyond the control of CAFP; alterations, modification or additions without written permission from CAFP, or from failures or corrosion due to:

- Improper installation.
- Misapplication – product used outside of specified use.
- Damage from handling, transportation, installation, vehicular impact, abuse, or vandalism.
- Site specific wind induced or other vibration.
- Installation in soils with a pH under 5 or over 9.
- Installation using highly caustic grouts or concrete.
- Improper grounding.

All warranty claims must be directed to: **CONCORD AMERICAN FLAGPOLE**, Customer Service Department, 4155 Patriot Drive, Suite 100, Grapevine, TX 76051. The Flagpole shall not be returned without prior written authorization of CAFP and must be shipped freight prepaid by the Buyer. If CAFP elects to replace the nonconforming Flagpole, such replaced Flagpole shall become the property of CAFP.

CAFP MAKES NO OTHER EXPRESS WARRANTY AND EXPRESSLY DISCLAIMS ANY WARRANTY OF MERCHANTABILITY OR FITNESS FOR A PARTICULAR PURPOSE AND ALL OTHER IMPLIED WARRANTIES OTHER THAN THOSE THAT MAY NOT BE DISCLAIMED AS A MATTER OF LAW. THE DURATION OF ANY IMPLIED WARRANTY THAT MAY NOT BE DISCLAIMED BY APPLICABLE STATE OR FEDERAL LAW IS LIMITED TO THE WARRANTY PERIOD.

Regardless of whether a claim against CAFP is based on the Warranty or is an action in contract, tort (negligence or strict liability) or otherwise, CAFP's liability for losses, damages, or expenses of any kind arising from the design, manufacture, installation, use, repair, or sale of the flagpole is limited, unless otherwise prohibited by applicable law, to an amount not exceeding the cost of the CAFP flagpole giving rise to such liability. CAFP shall not be liable or responsible for any indirect, incidental, consequential or special damages.

Some states do not allow limitations on how long an implied warranty lasts or the exclusion or limitation of incidental or consequential damages, so the above limitations and exclusion may not apply to you. This warranty gives you specific legal rights and you may also have other rights which may vary from state-to-state.

This Warranty applies only to Concord American Flagpole aluminum pole assemblies shipped on or after January 1, 2018.

CONCORD AMERICAN FLAGPOLE
 Customer Service Department
 4155 Patriot Drive
 Suite 100
 Grapevine, TX 76051
 800-527-3902
www.concordamericanflagpole.com





POLELED

 PROFESSIONAL FLAGPOLE LIGHT 

see page 84 to learn more...



PHONE: 800-527-3902

Corporate Headquarters

4155 Patriot Drive
Grapevine, TX 76051
Phone: 972-380-8186

Manufacturing and Shipping Locations:

4155 Patriot Drive · Grapevine, TX 76051
26252 Hillman Highway · Abingdon, VA 24210
1030 Lone Oak Rd · Eagan, MN 55121
www.ConcordAmericanFlagpole.com
email: info@ConcordAmericanFlagpole.com

